



# **IPS-3082GC / IPS-3082GC-24V**

## **Industrial Managed Ethernet Switch**

# **User's Manual**

**Version 3.0**

**Mar, 2013**

[www.oring-networking.com](http://www.oring-networking.com)



## COPYRIGHT NOTICE

Copyright © 2010 ORing Industrial Networking Corp.

All rights reserved.

No part of this publication may be reproduced in any form without the prior written consent of ORing Industrial Networking Corp.

## TRADEMARKS



is a registered trademark of ORing Industrial Networking Corp.

All other trademarks belong to their respective owners.

## REGULATORY COMPLIANCE STATEMENT

Product(s) associated with this publication complies/comply with all applicable regulations.

Please refer to the Technical Specifications section for more details.

## WARRANTY

ORing warrants that all ORing products are free from defects in material and workmanship for a specified warranty period from the invoice date (5 years for most products). ORing will repair or replace products found by ORing to be defective within this warranty period, with shipment expenses apportioned by ORing and the distributor. This warranty does not cover product modifications or repairs done by persons other than ORing-approved personnel, and this warranty does not apply to ORing products that are misused, abused, improperly installed, or damaged by accidents.

Please refer to the Technical Specifications section for the actual warranty period(s) of the product(s) associated with this publication.

## DISCLAIMER

Information in this publication is intended to be accurate. ORing shall not be responsible for its use or infringements on third-parties as a result of its use. There may occasionally be unintentional errors on this publication. ORing reserves the right to revise the contents of this publication without notice.

## CONTACT INFORMATION

### **ORing Industrial Networking Corp.**

4F., NO.3, Lane235, Baociao Rd., Sindian City, Taipei County 23145, Taiwan, R.O.C.

Tel: + 886 2 2918 3036 // Fax: + 886 2 2918 3084

Website: [www.oring-networking.com](http://www.oring-networking.com)

### **Technical Support**

E-mail: [support@oring-networking.com](mailto:support@oring-networking.com)

### **Sales Contact**

E-mail: [sales@oring-networking.com](mailto:sales@oring-networking.com) (Headquarters)

[sales@oring-networking.com.cn](mailto:sales@oring-networking.com.cn) (China)



# Table of Content

<b>Getting to Know Your Switch</b> .....	<b>6</b>
1.1 About the IPS-3082GC / IPS-3082GC-24V Managed Industrial Switch .....	6
1.2 Software Features .....	6
1.3 Hardware Features.....	7
<b>Hardware Installation</b> .....	<b>8</b>
2.1 Installing Switch on DIN-Rail.....	8
2.1.1 Mount IPS-3082GC SERIES on DIN-Rail.....	8
2.2 Wall Mounting Installation .....	9
<b>Hardware Overview</b> .....	<b>10</b>
3.1 Front Panel.....	10
3.2 Front Panel LEDs .....	12
3.3 Top view Panel.....	13
<b>Cables</b> .....	<b>14</b>
4.1 Ethernet Cables .....	14
4.1.1 100BASE-TX/10BASE-T Pin Assignments.....	14
4.2 SFP.....	16
4.3 Console Cable.....	16
<b>WEB Management</b> .....	<b>17</b>
5.1 Configuration by Web Browser .....	17
5.1.1 About Web-based Management.....	17
5.1.2 System Information.....	19
5.1.3 Front Panel .....	19
5.1.4 Basic setting .....	20
5.1.4.1 Switch Setting.....	20
5.1.4.2 Admin Password.....	20
5.1.4.3 IP Setting.....	21
5.1.4.4 Time Setting .....	22
5.1.4.5 LLDP .....	26
5.1.4.6 Modbus TCP .....	26
5.1.4.7 Auto Provision.....	27



- 5.1.4.8 Backup & Restore..... 27
- 5.1.4.9 Upgrade Firmware..... 29
- 5.1.1 Redundancy..... 29
  - 5.1.1.1 MRP..... 29
  - 5.1.1.2 O-Ring ..... 30
  - 5.1.1.3 OPEN-Ring ..... 31
  - 5.1.1.4 O-Chain..... 32
  - 5.1.1.5 RSTP – Repeater..... 33
  - 5.1.1.6 Fast Recovery..... 34
  - 5.1.1.7 RSTP..... 35
  - 5.1.1.8 MSTP..... 37
- 5.1.2 Multicast..... 42
  - 5.1.2.1 IGMP Snooping..... 42
  - 5.1.2.2 MVR..... 43
  - 5.1.2.3 Static Multicast Filtering..... 44
- 5.1.3 Port Setting..... 45
  - 5.1.3.1 Port Control..... 45
  - 5.1.3.2 Port Status ..... 46
  - 5.1.3.3 Port Alias..... 47
  - 5.1.3.4 Rate Limit ..... 47
  - 5.1.3.5 Port Trunk ..... 48
  - 5.1.3.6 Loop Guard ..... 50
- 5.1.4 VLAN ..... 51
  - 5.1.4.1 VLAN Setting - IEEE 802.1Q..... 51
  - 5.1.4.2 VLAN Setting – Port Based ..... 52
- 5.1.5 Traffic Priorilization..... 55
  - 5.1.5.1 Qos policy ..... 55
  - 5.1.5.2 Port-base priority ..... 56
  - 5.1.5.3 COS/802.1p..... 56
  - 5.1.5.4 TOS/DSCP ..... 57
- 5.1.6 DHCP Server ..... 58
  - 5.1.6.1 DHCP Server – Setting ..... 58
  - 5.1.6.2 DHCP Server – Client List ..... 59
  - 5.1.6.3 DHCP Server – Port and IP bindings ..... 59
  - 5.1.6.4 DHCP Server –DHCP Relay Agent ..... 59
- 5.1.7 SNMP..... 61
  - 5.1.7.1 SNMP – Agent Setting ..... 61



5.1.7.2	SNMP –Trap Setting.....	62
5.1.7.3	SNMPV3.....	63
5.1.8	Security.....	65
5.1.8.1	Management Security.....	65
5.1.8.2	Static MAC Forwarding.....	66
5.1.8.3	MAC Blacklist.....	67
5.1.8.4	802.1x.....	67
5.1.8.5	IP Guard.....	70
5.1.9	Warning.....	73
5.1.10	Monitor and Diag.....	77
5.1.10.1	System Event Log.....	77
5.1.10.2	MAC Address Table.....	78
5.1.10.3	Port Overview.....	79
5.1.10.4	Port Counters.....	80
5.1.10.5	Port Monitoring.....	82
5.1.10.6	Traffic Monitor.....	83
5.1.10.7	SFP Monitor.....	84
5.1.10.8	Ping.....	84
5.1.11	Power over Ethernet (P.O.E.).....	85
5.1.11.1	System setting.....	85
5.1.11.2	Power over Ethernet - Port Control.....	86
5.1.11.3	Port Status.....	87
5.1.11.4	Power over Ethernet – Boot Delay.....	87
5.1.11.5	Ping Alive Check.....	88
5.1.11.6	Schedule.....	89
5.1.12	Save Configuration.....	90
5.1.13	Factory Default.....	90
5.1.14	System Reboot.....	90

## **Command Line Interface Management ..... 91**

6.1	About CLI Management.....	91
6.2	Commands Set List—System Commands Set.....	96
6.3	Commands Set List—Port Commands Set.....	98
6.4	Commands Set List—Trunk command set.....	101
6.5	Commands Set List—VLAN command set.....	102
6.6	Commands Set List—Spanning Tree command set.....	103
6.7	Commands Set List—QoS command set.....	106
6.8	Commands Set List—IGMP command set.....	106



6.9	Commands Set List—MAC/Filter Table command set.....	107
6.10	Commands Set List—SNMP command set.....	108
6.11	Commands Set List—Port Mirroring command set.....	109
6.12	Commands Set List—802.1x command set.....	109
6.13	Commands Set List—TFTP command set .....	112
6.14	Commands Set List—SYSLOG, SMTP, EVENT command set .....	112
6.15	Commands Set List—SNTP command set.....	114
6.16	Commands Set List—O-Ring command set.....	115
<b>Technical Specifications .....</b>		<b>0</b>

# **Getting to Know Your Switch**

## **1.1 About the IPS-3082GC / IPS-3082GC-24V Managed Industrial Switch**

The IPS-3082GC / IPS-3082GC-24V is powerful managed industrial switch with many features. The switch can work under wide temperature, dusty environment and humid condition.

IPS-3082GC / IPS-3082GC-24V support Power over Ethernet, a system to transmit electrical power with data to remote devices over standard twisted-pair cable. The IPS-3082GC / IPS-3082GC-24V has 8 X 10/100Base-T(X) P.S.E. (Power Sourcing Equipment) ports which are fully compliant with IEEE 802.3af standard.

The IPS-3082GC / IPS-3082GC-24V can be managed by WEB, TELNET, Console or other third-party SNMP software as well. Besides, the switch can be managed by a useful utility that we called Open-Vision. Open-Vision is powerful network management software. With its friendly and powerful interface, you can easily configure multiple switches at the same time, and monitor switches' status.

## **1.2 Software Features**

- World's fastest Redundant Ethernet Ring : O-Ring (Recovery time < 10ms over 250 units connection)
- Supports Ring Coupling, Dual Homing over O-Ring
- Supports SNMPv1/v2/v3 & RMON & Port base/802.1Q VLAN Network Management
- Event notification by Email, SNMP trap and Relay Output
- Web-based ,Telnet, Console, CLI configuration
- Enable/disable ports, MAC based port security
- Port based network access control (802.1x)
- VLAN (802.1Q ) to segregate and secure network traffic
- Radius centralized password management
- SNMPv3 encrypted authentication and access security
- RSTP (802.1w)
- Quality of Service (802.1p) for real-time traffic
- VLAN (802.1Q) with double tagging and GVRP supported
- IGMP Snooping for multicast filtering
- Port configuration, status, statistics, mirroring, security
- Remote Monitoring (RMON)

## 1.3 Hardware Features

- Redundant two DC power inputs
- Wide Operating Temperature: -40 to 70°C
- Storage Temperature: -40 to 85°C
- Operating Humidity: 5% to 95%, non-condensing
- Casing: IP-30
- 10/100Base-T(X) Ethernet port
- 10/100/1000Base-T(X) Gigabit Ethernet port (combo)
- 100/1000Base-X on SFP port (combo)
- Console Port
- Dimensions(W x D x H) : 74.3 mm(W)x 109.2 mm( D )x 153.6 mm(H)



# Hardware Installation

## 2.1 Installing Switch on DIN-Rail

Each switch has a DIN-Rail kit on rear panel. The DIN-Rail kit helps switch to fix on the DIN-Rail. It is easy to install the switch on the DIN-Rail:

### 2.1.1 Mount IPS-3082GC SERIES on DIN-Rail

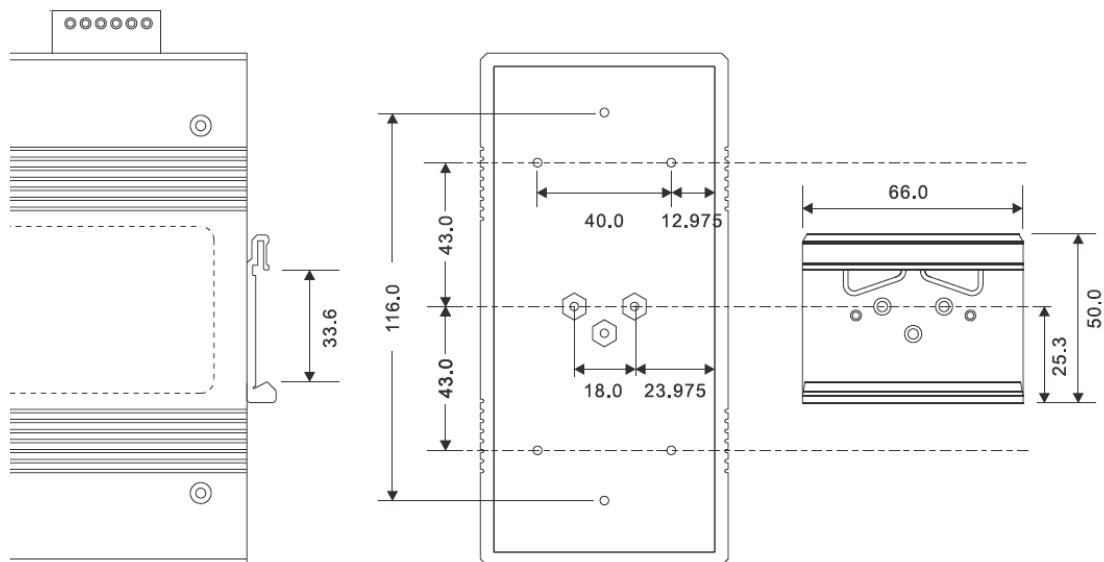

DIN-Rail Size

## 2.2 Wall Mounting Installation

Each switch has another installation method for users to fix the switch. A wall mount panel can be found in the package. The following steps show how to mount the switch on the wall:

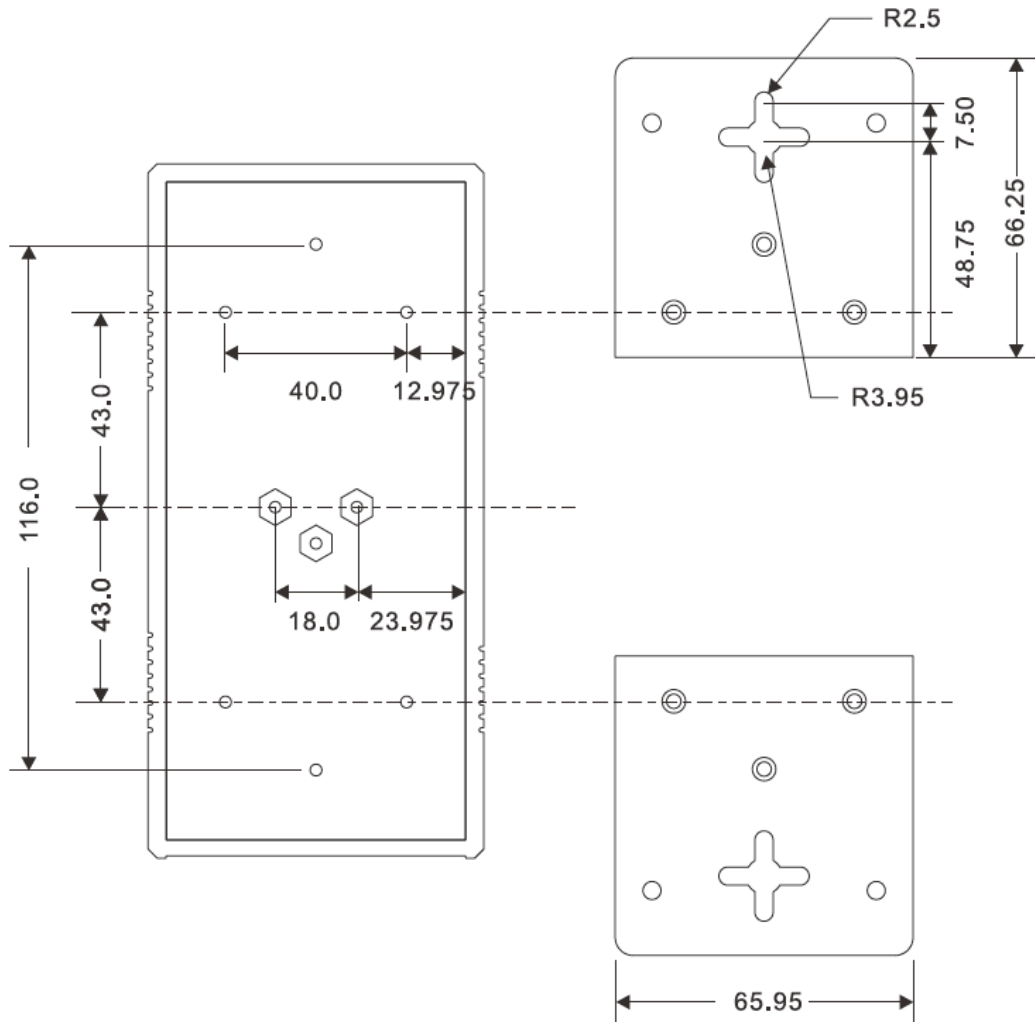

Wall-Mounting size

# Hardware Overview

## 3.1 Front Panel

The following table describes the labels that stick on the IPS-3082GC / IPS-3082GC-24V.

Port	Description
<b>10/100 RJ-45 fast Ethernet ports</b>	8 10/100Base-T(X) RJ-45 fast Ethernet ports support auto-negotiation. Default Setting : Speed: auto Duplex: auto Flow control : disable
<b>Gigabit RJ-45 ports</b>	2 10/100/1000Base-T(X) Gigabit ports (combo ports)
<b>SFP ports</b>	2 100/1000Base-X on SFP port (combo)
<b>P.O.E. Ports</b>	Port 1 ~ 8 contain P.S.E. function compliant with IEEE802.3af P.O.E. specifications.
<b>Console</b>	Use RS-232 to RJ-45 connector to manage switch.
<b>Reset</b>	Push reset button 2 to 3 seconds to reset the switch. Push reset button 5 seconds to reset the switch into <b>Factory Default</b> .

### IPS-3082GC / IPS-3082GC-24V

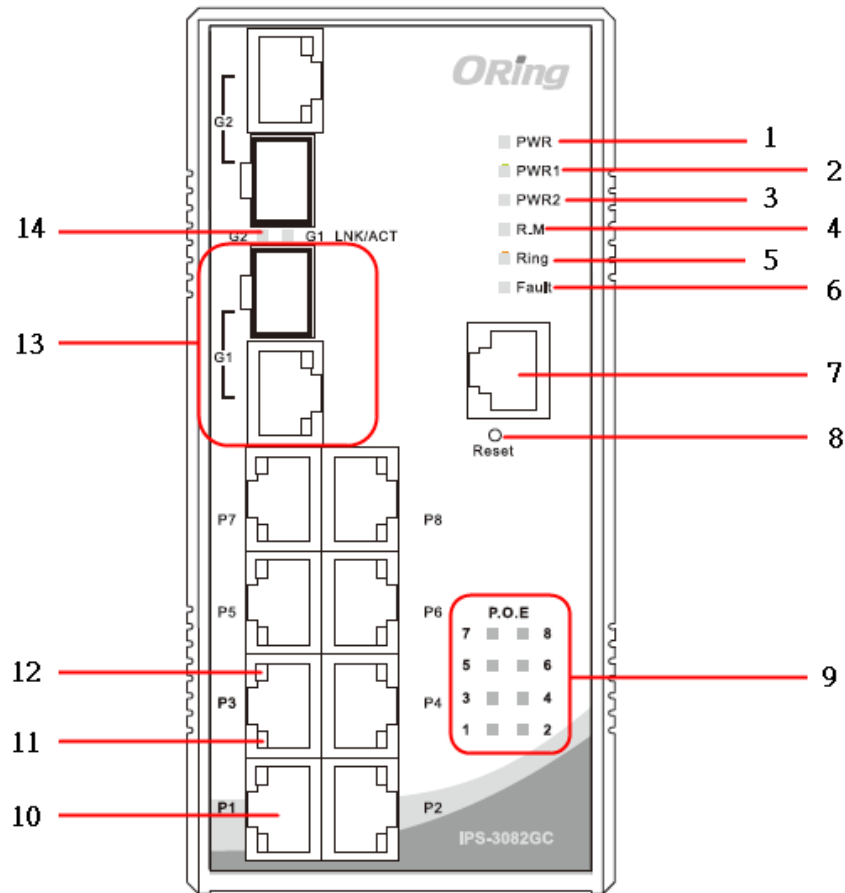

1. LED for PWR. When the PWR links, the green led will be light on.
2. LED for PWR1. When the PWR1 links, the green led will be light on.
3. LED for PWR2. When the PWR2 links, the green led will be light on.
4. LED for R.M (Ring master). When the LED light on, it means that the switch is the ring master of O-Ring.
5. LED for Ring. When the led light on, it means the O-Ring is activated.
6. LED for Fault Relay. When the fault occurs, the amber LED will be light on.
7. Console port (RJ-45).
8. Reset button. Push the button 3 seconds for reset; 5 seconds for factory default.
9. LED for P.O.E. power supplied.
10. 10/100Base-T(X) P.S.E. Ethernet ports.
11. LED for Ethernet ports speed.
12. LED for Ethernet ports link status.
13. 1000 COMBO ports with SFP
14. LED for SFP ports link/Act status.



## 3.2 Front Panel LEDs

LED	Color	Status	Description
<b>PWR</b>	Green	On	DC power ready
<b>PW1</b>	Green	On	DC power module 1 activated.
<b>PW2</b>	Green	On	DC power module 2 activated.
<b>R.M</b>	Green	On	O-Ring Master.
<b>Ring</b>	Green	On	O-Ring enabled.
		Slowly blinking	O-Ring topology has problem
		Fast blinking	O-Ring work normally.
<b>Fault</b>	Amber	On	Fault relay. Power failure or Port down/fail.
10/100Base-T(X) Fast Ethernet ports			
<b>LNK / ACT</b>	Green	On	Port link up.
		Blinking	Data transmitted.
<b>Full Duplex</b>	Amber	On	Port works under full duplex.
Gigabit Ethernet ports			
<b>ACT</b>	Green	On	Port link up.
		Blinking	Data transmitted.
<b>LNK</b>	Amber	On	Port link up.
SFP ports			
<b>LNK / ACT</b>	Green	On	Port link up.
		Blinking	Data transmitted.

### 3.3 Top view Panel

The bottom panel components of IPS-3082GC / IPS-3082GC-24V are shown as below:

1. Terminal block includes:
2. Ground wire

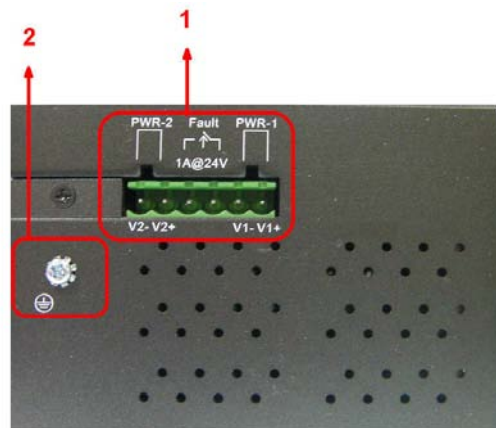

# Cables

## 4.1 Ethernet Cables

The IPS-3082GC / IPS-3082GC-24V switch have standard Ethernet ports. According to the link type, the switches use CAT 3, 4, 5, 5e UTP cables to connect to any other network device (PCs, servers, switches, routers, or hubs). Please refer to the following table for cable specifications.

Cable Types and Specifications

Cable	Type	Max. Length	Connector
10BASE-T	Cat.3, 4, 5 100-ohm	UTP 100 m (328 ft)	RJ-45
100BASE-TX	Cat.5 100-ohm UTP	UTP 100 m (328 ft)	RJ-45
1000BASE-TX	Cat.5/Cat.5e 100-ohm UTP	UTP 100 m (328ft)	RJ-45

### 4.1.1 100BASE-TX/10BASE-T Pin Assignments

With 100BASE-TX/10BASE-T cable, pins 1 and 2 are used for transmitting data, and pins 3 and 6 are used for receiving data.

10/100 P.S.E. Base-TX RJ-45 Pin Assignments

Pin Number	Assignment
1	P.O.E Power input +
2	P.O.E Power input +
3	P.O.E Power input -
4	Not used
5	Not used
6	P.O.E Power input -
7	Not used
8	Not used



## 1000 Base-T RJ-45 Pin Assignments

Pin Number	Assignment
1	BI_DA+
2	BI_DA-
3	BI_DB+
4	BI_DC+
5	BI_DC-
6	BI_DB-
7	BI_DD+
8	BI_DD-

The IPS-3082GC / IPS-3082GC-24V switch support auto MDI/MDI-X operation. You can use a straight-through cable to connect PC to switch. The following table below shows the 10BASE-T/ 100BASE-TX MDI and MDI-X port pin outs.

## 10/100 Base-TX MDI/MDI-X pins assignment

Pin Number	MDI port	MDI-X port
1	TD+(transmit)	RD+(receive)
2	TD-(transmit)	RD-(receive)
3	RD+(receive)	TD+(transmit)
4	Not used	Not used
5	Not used	Not used
6	RD-(receive)	TD-(transmit)
7	Not used	Not used
8	Not used	Not used

## 1000 Base-T MDI/MDI-X pins assignment

Pin Number	MDI port	MDI-X port
1	BI_DA+	BI_DB+
2	BI_DA-	BI_DB-
3	BI_DB+	BI_DA+
4	BI_DC+	BI_DD+
5	BI_DC-	BI_DD-
6	BI_DB-	BI_DA-
7	BI_DD+	BI_DC+
8	BI_DD-	BI_DC-

**Note:** "+" and "-" signs represent the polarity of the wires that make up each wire pair.



## 4.2 SFP

The switch has fiber optical ports with SFP connectors. The fiber optical ports are in multi-mode (0 to 550M, 850 nm with 50/125  $\mu\text{m}$ , 62.5/125  $\mu\text{m}$  fiber) and single-mode with LC connector. Please remember that the TX port of Switch A should be connected to the RX port of Switch B.

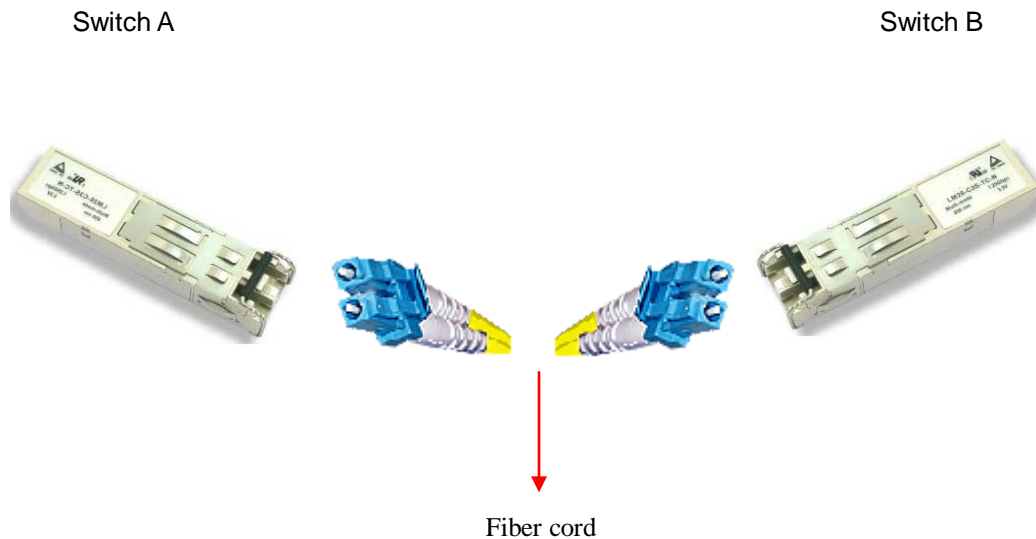

## 4.3 Console Cable

IPS-3082GC / IPS-3082GC-24V switches can be management by console port. The DB-9 to RJ-45 cable can be found in the package. You can connect them to PC via a RS-232 cable with DB-9 female connector and the other end (RJ-45 connector) connects to console port of switch.

PC pin out (male) assignment	RS-232 with DB9 female connector	DB9 to RJ 45
Pin #2 RD	Pin #2 TD	Pin #2
Pin #3 TD	Pin #3 RD	Pin #3
Pin #5 GD	Pin #5 GD	Pin #5

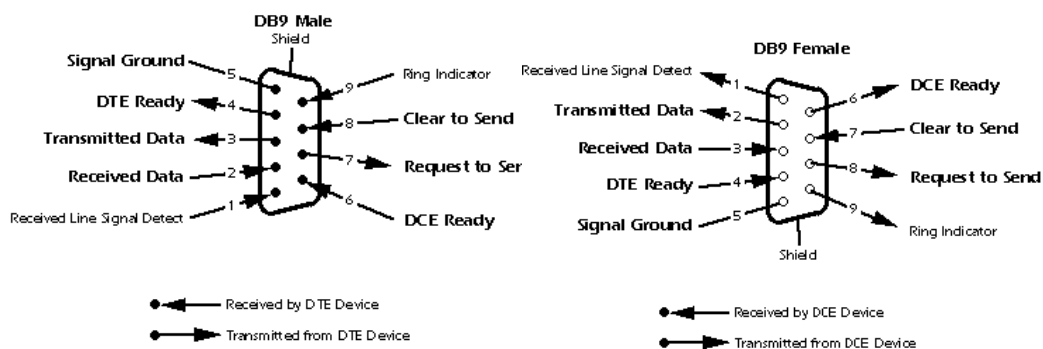

# WEB Management



## 5.1 Configuration by Web Browser

This section introduces the configuration by Web browser.

### 5.1.1 About Web-based Management

An embedded HTML web site resides in flash memory on the CPU board. It contains advanced management features and allows you to manage the switch from anywhere on the network through a standard web browser such as Microsoft Internet Explorer.

The Web-Based Management function supports Internet Explorer 5.0 or later. It is based on Java Applets with an aim to reduce network bandwidth consumption, enhance access speed and present an easy viewing screen.

**Note:** By default, IE5.0 or later version does not allow Java Applets to open sockets. You need to explicitly modify the browser setting in order to enable Java Applets to use network ports.

### Preparing for Web Management

The default value is as below:

IP Address: **192.168.10.1**

Subnet Mask: **255.255.255.0**

Default Gateway: **192.168.10.254**

User Name: **admin**

Password: **admin**

### System Login

1. Launch the Internet Explorer.
2. Type http:// and the IP address of the switch. Press "**Enter**".

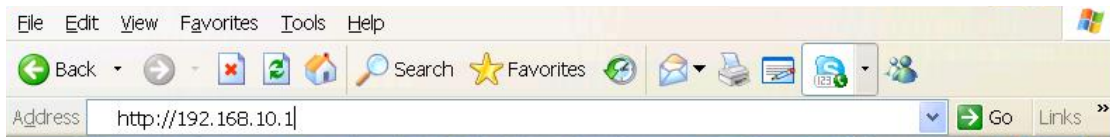

3. The login screen appears.
4. Key in the username and password. The default username and password is "admin".
5. Click "Enter" or "OK" button, then the main interface of the Web-based management appears.

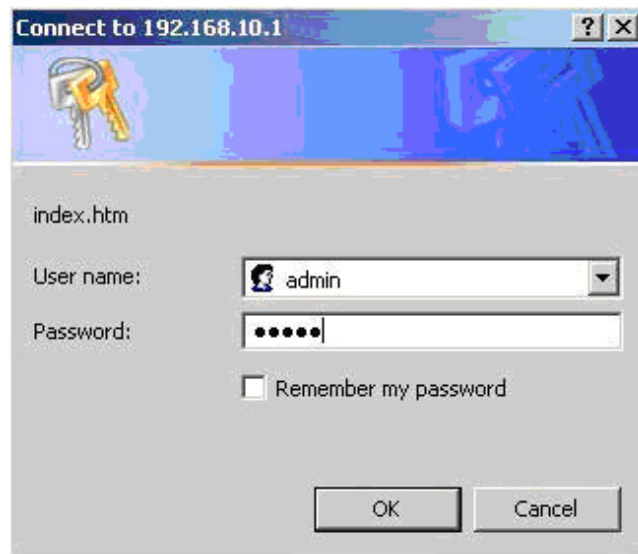

Login screen

## Main Interface

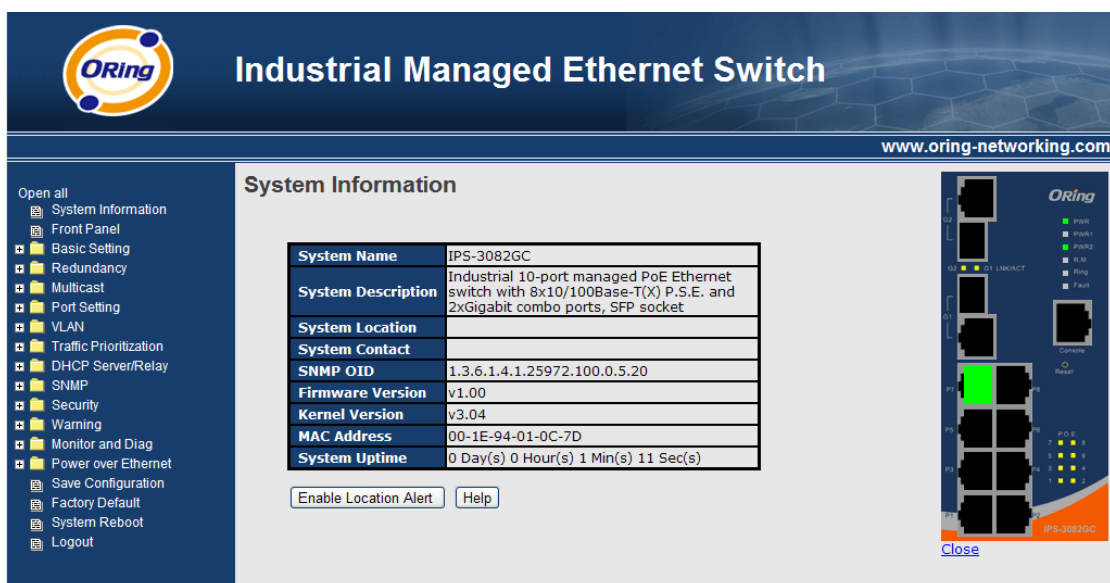

Main interface

## 5.1.2 System Information

### System Information

<b>System Name</b>	IPS-3082GC
<b>System Description</b>	Industrial 10-port managed PoE Ethernet switch with 8x10/100Base-T(X) P.S.E. and 2xGigabit combo ports, SFP socket
<b>System Location</b>	
<b>System Contact</b>	
<b>SNMP OID</b>	1.3.6.1.4.1.25972.100.0.5.20
<b>Firmware Version</b>	v1.00
<b>Kernel Version</b>	v3.04
<b>MAC Address</b>	00-1E-94-01-0C-7D
<b>System Uptime</b>	0 Day(s) 0 Hour(s) 1 Min(s) 37 Sec(s)

System Information interface

### System Information

The system information will display the configuration of Basic Setting / Switch Setting page.

#### Enable Location Alert

When click  , PWR1, PWR2 and PWR3 LEDs of the switch will start to flash together, and click  , the LEDs will stop flashing.

## 5.1.3 Front Panel

Show the panel of IPS-3082GC / IPS-3082GC-24V. Click “Close” to close panel on web.

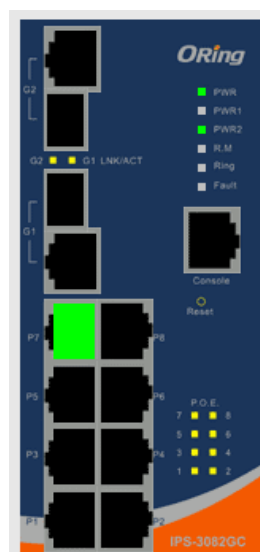

## 5.1.4 Basic setting

### 5.1.4.1 Switch Setting

**System Setting**

<b>System Name</b>	IPS-3082GC
<b>System Description</b>	Industrial 10-port managed PoE Ethernet switch with 8x10/100Base-T(X)
<b>System Location</b>	
<b>System Contact</b>	

Switch setting interface

The following table describes the labels in this screen.

Label	Description
<b>System Name</b>	Assign the name of switch. The maximum length is 64 bytes
<b>System Description</b>	Display the description of switch.
<b>System Location</b>	Assign the switch physical location. The maximum length is 64 bytes
<b>System Contact</b>	Enter the name of contact person or organization

### 5.1.4.2 Admin Password

Change web management login username and password for the management security issue

**Admin Password**

<b>User Name</b>	admin
<b>New Password</b>	
<b>Confirm Password</b>	

Admin Password interface

The following table describes the labels in this screen.

Label	Description
<b>User name</b>	Key in the new username (The default is “ <b>admin</b> ”)
<b>New Password</b>	Key in the new password (The default is “ <b>admin</b> ”)
<b>Confirm password</b>	Re-type the new password.
<b>Apply</b>	Click “ <b>Apply</b> ” to activate the configurations.

### 5.1.4.3 IP Setting

You can configure the IP Settings and DHCP client function through IP configuration.

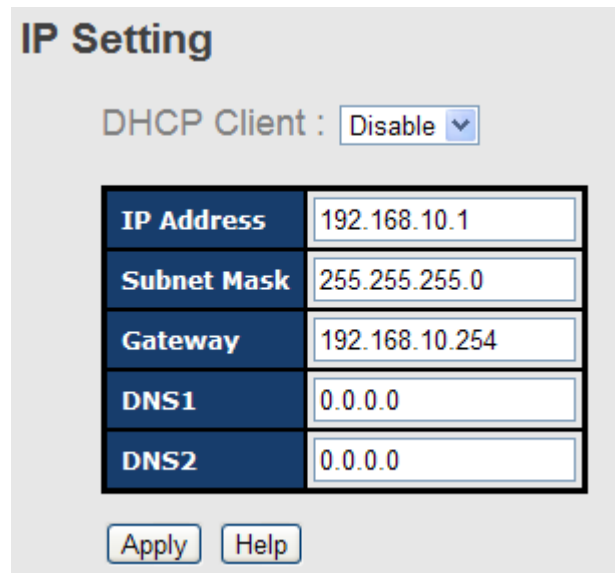

**IP Setting**

DHCP Client :

<b>IP Address</b>	192.168.10.1
<b>Subnet Mask</b>	255.255.255.0
<b>Gateway</b>	192.168.10.254
<b>DNS1</b>	0.0.0.0
<b>DNS2</b>	0.0.0.0

IP Configuration interface

The following table describes the labels in this screen.

Label	Description
<b>DHCP Client</b>	To enable or disable the DHCP client function. When DHCP client function is enabling, the switch will be assigned the IP address from the network DHCP server. The default IP address will be replaced by the IP address which the DHCP server has assigned. After clicking “ <b>Apply</b> ” button, a popup dialog shows up to inform when the DHCP client is enabling. The current IP will lose and you should find a new IP on the DHCP server.
<b>IP Address</b>	Assign the IP address that the network is using. If DHCP client function is enabling, you do not need to assign the IP address. The network DHCP server will assign the IP address for the

	switch and it will be display in this column. The default IP is 192.168.10.1
<b>Subnet Mask</b>	Assign the subnet mask of the IP address. If DHCP client function is enabling, you do not need to assign the subnet mask
<b>Gateway</b>	Assign the network gateway for the switch. The default gateway is 192.168.10.254
<b>DNS1</b>	Assign the primary DNS IP address
<b>DNS2</b>	Assign the secondary DNS IP address
<b>Apply</b>	Click " <b>Apply</b> " to activate the configurations.

#### 5.1.4.4 Time Setting

This page includes configurations of SNTP and system clock.

#### System Clock

### Time Setting

System Clock

<b>System Clock</b>	Thu Jan 01 1970 00:39:12 GMT+0800 (台北標準時間)		
<b>System Date (YYYY/MM/DD)</b>	<input type="text" value="2012"/>	<input type="text" value="Jun"/>	<input type="text" value="22"/>
<b>System Time (hh:mm:ss)</b>	<input type="text" value="15"/>	<input type="text" value="43"/>	<input type="text" value="42"/>

The following table describes the labels in this screen.

Label	Description
<b>System clock</b>	This field shows the current system timer. The time stamp could be assigned by manual configuration or by SNTP server.
<b>System Date</b>	Specify the year, month and day of system clock(YYYY/MM/DD). Year:2006-2015. Month: Jan-Dec. Day:1-31(28)
<b>System Time</b>	Specify the hour, minute and second of system clock(hh:mm:ss). Hour:0-24, Minute:0-59, Second:0-59

## SNTP

The SNTP (Simple Network Time Protocol) settings allow you to synchronize switch clocks in the Internet.

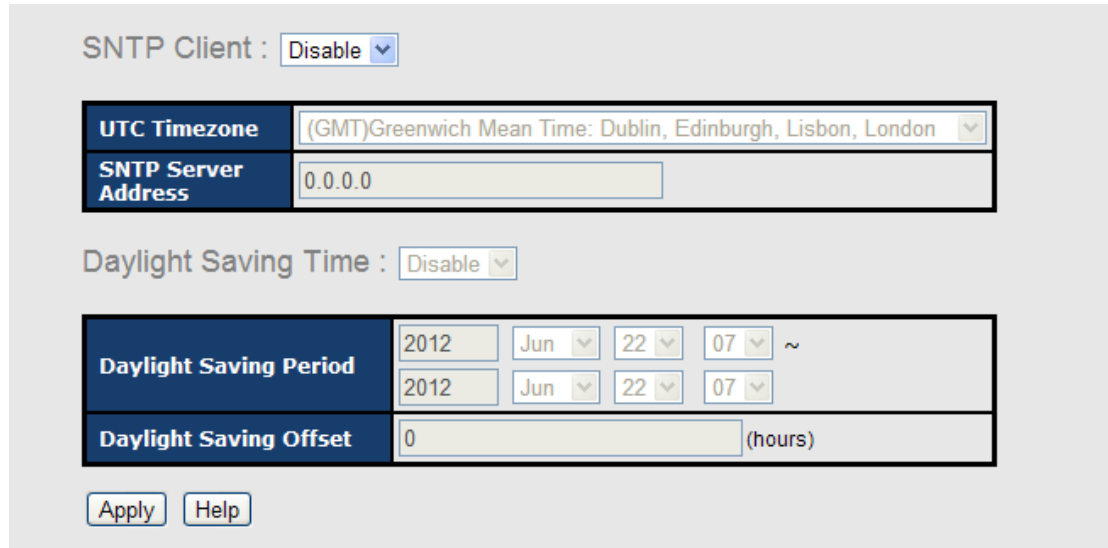

The screenshot shows the SNTP configuration interface. At the top, there is a dropdown menu for 'SNTP Client' set to 'Disable'. Below this is a table with two rows: 'UTC Timezone' with a dropdown menu showing '(GMT)Greenwich Mean Time: Dublin, Edinburgh, Lisbon, London' and 'SNTP Server Address' with a text input field containing '0.0.0.0'. Underneath is another 'Daylight Saving Time' dropdown menu set to 'Disable'. Below that is another table with three rows: 'Daylight Saving Period' with two rows of date pickers (Year, Month, Day, Hour) and a tilde symbol, and 'Daylight Saving Offset' with a text input field containing '0' and '(hours)'. At the bottom left are 'Apply' and 'Help' buttons.

SNTP Configuration interface

The following table describes the labels in this screen.

Label	Description
<b>SNTP Client</b>	Enable or disable SNTP function to get the time from the SNTP server.
<b>Daylight Saving Time</b>	Enable or disable daylight saving time function. When daylight saving time is enabling, you need to configure the daylight saving time period.
<b>UTC Time zone</b>	Set the switch location time zone. The following table lists the different location time zone for your reference.

Local Time Zone	Conversion from UTC	Time at 12:00 UTC
November Time Zone	- 1 hour	11 am
Oscar Time Zone	-2 hours	10 am
ADT - Atlantic Daylight	-3 hours	9 am
AST - Atlantic Standard EDT - Eastern Daylight	-4 hours	8 am
EST - Eastern Standard	-5 hours	7 am





CDT - Central Daylight		
CST - Central Standard MDT - Mountain Daylight	-6 hours	6 am
MST - Mountain Standard PDT - Pacific Daylight	-7 hours	5 am
PST - Pacific Standard ADT - Alaskan Daylight	-8 hours	4 am
ALA - Alaskan Standard	-9 hours	3 am
HAW - Hawaiian Standard	-10 hours	2 am
Nome, Alaska	-11 hours	1 am
CET - Central European FWT - French Winter MET - Middle European MEWT - Middle European Winter SWT - Swedish Winter	+1 hour	1 pm
EET - Eastern European, USSR Zone 1	+2 hours	2 pm
BT - Baghdad, USSR Zone 2	+3 hours	3 pm
ZP4 - USSR Zone 3	+4 hours	4 pm
ZP5 - USSR Zone 4	+5 hours	5 pm
ZP6 - USSR Zone 5	+6 hours	6 pm
WAST - West Australian Standard	+7 hours	7 pm
CCT - China Coast, USSR Zone 7	+8 hours	8 pm
JST - Japan Standard, USSR Zone 8	+9 hours	9 pm
EAST - East Australian Standard GST	+10 hours	10 pm



Guam Standard, USSR Zone 9		
IDLE - International Date Line NZST - New Zealand Standard NZT - New Zealand	+12 hours	Midnight

Label	Description
<b>SNTP Sever IP Address</b>	Set the SNTP server IP address.
<b>Daylight Saving Period</b>	Set up the Daylight Saving beginning time and Daylight Saving ending time. Both will be different each year.
<b>Daylight Saving Offset</b>	Set up the offset time.
<b>Switch Timer</b>	Display the switch current time.
<b>Apply</b>	Click " <b>Apply</b> " to activate the configurations.

## PTP Client

The Precision Time Protocol (PTP) is a time-transfer protocol defined in the IEEE 1588-2002 standard that allows precise synchronization of networks (e.g., Ethernet). Accuracy within the nanosecond range can be achieved with this protocol when using hardware generated timestamps.

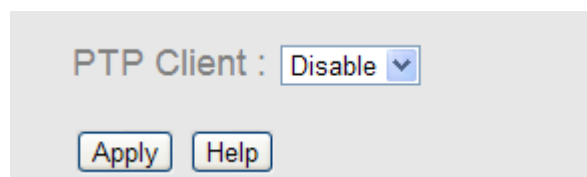

Label	Description
<b>PTP Client</b>	Enable / Disable PTP Client

### 5.1.4.5 LLDP

LLDP (Link Layer Discovery Protocol) function allows the switch to advertise its information to other nodes on the network and store the information it discovers.



Port	System Name	MAC Address	IP Address
Port. 8	IGS-3044GC	00-1E-94-3A-04-B0	192.168.10.20

LLDP configuration interface

The following table describes the labels in this screen.

Label	Description
<b>LLDP Protocol</b>	“Enable” or “Disable” LLDP function.
<b>LLDP Interval</b>	The interval of resend LLDP (by default at 30 seconds)
<b>Apply</b>	Click “ <b>Apply</b> ” to set the configurations.
<b>Help</b>	Show help file.
<b>Neighbor info table</b>	Can show neighbor device info .

### 5.1.4.6 Modbus TCP

Support Modbus TCP .(About Modbus please reference <http://www.modbus.org/>)

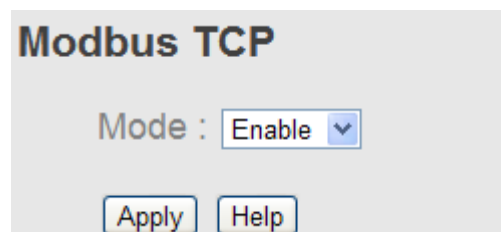

The following table describes the labels in this screen.

Label	Description
<b>Mode</b>	Enable or Disalble Modbus TCP function

### 5.1.4.7 Auto Provision

Auto Provision allows you to update the switch firmware automatically. You can put firmware or configuration file on TFTP server. When you reboot the switch, it will upgrade automatically. Before updating, make sure you have your TFTP server ready and the firmware image and configuration file is on the TFTP server.

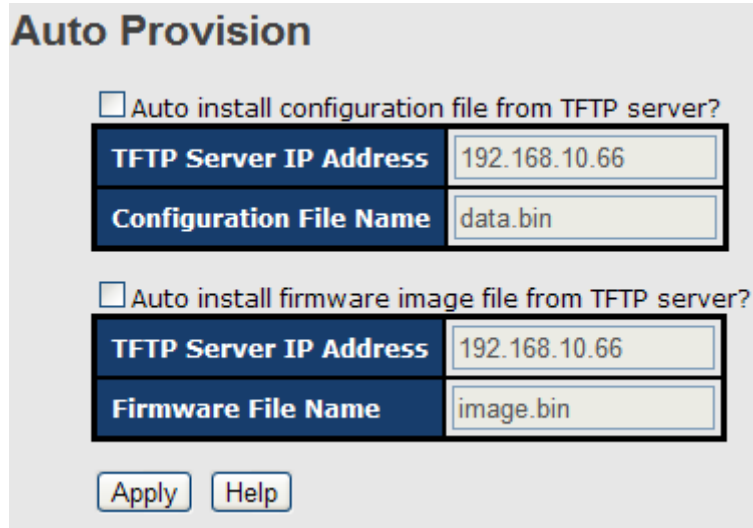

The screenshot shows the 'Auto Provision' web interface. It features two sections, each with a checkbox and two input fields. The first section is for configuration files, with the checkbox 'Auto install configuration file from TFTP server?' and input fields for 'TFTP Server IP Address' (192.168.10.66) and 'Configuration File Name' (data.bin). The second section is for firmware, with the checkbox 'Auto install firmware image file from TFTP server?' and input fields for 'TFTP Server IP Address' (192.168.10.66) and 'Firmware File Name' (image.bin). At the bottom are 'Apply' and 'Help' buttons.

Auto Provision interface

### 5.1.4.8 Backup & Restore

You can save current EEPROM value from the switch to TFTP server, then go to the TFTP restore configuration page to restore the EEPROM value.

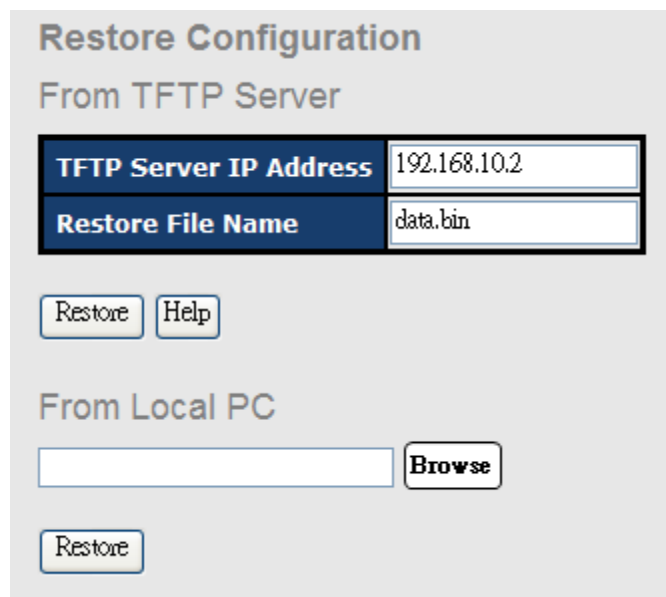

The screenshot shows the 'Restore Configuration' web interface. It has two main sections: 'From TFTP Server' and 'From Local PC'. The 'From TFTP Server' section includes input fields for 'TFTP Server IP Address' (192.168.10.2) and 'Restore File Name' (data.bin), with 'Restore' and 'Help' buttons below. The 'From Local PC' section includes a file selection input field with a 'Browse' button and a 'Restore' button below.

### Backup Configuration

To TFTP Server

<b>TFTP Server IP Address</b>	192.168.10.2
<b>Backup File Name</b>	data.bin

To Local PC

Backup &amp; Restore interface

The following table describes the labels in this screen.

Label	Description
<b>TFTP Server IP Address</b>	Fill in the TFTP server IP
<b>Restore File Name</b>	Fill the file name.
<b>Restore</b>	Click " <b>restore</b> " to restore the configurations.
<b>Form Local PC</b>	User can select file restore , not need TFTP server .
<b>Restore File Name</b>	Fill the file name.
<b>Restore</b>	Click " <b>restore</b> " to restore the configurations.
<b>Backup</b>	Click " <b>backup</b> " to backup the configurations.
<b>To Local PC</b>	User can download config file to switch . not need TFTP server

### 5.1.4.9 Upgrade Firmware

Upgrade Firmware allows you to update the switch firmware. Before updating, make sure you have your TFTP server ready and the firmware image is on the TFTP server.

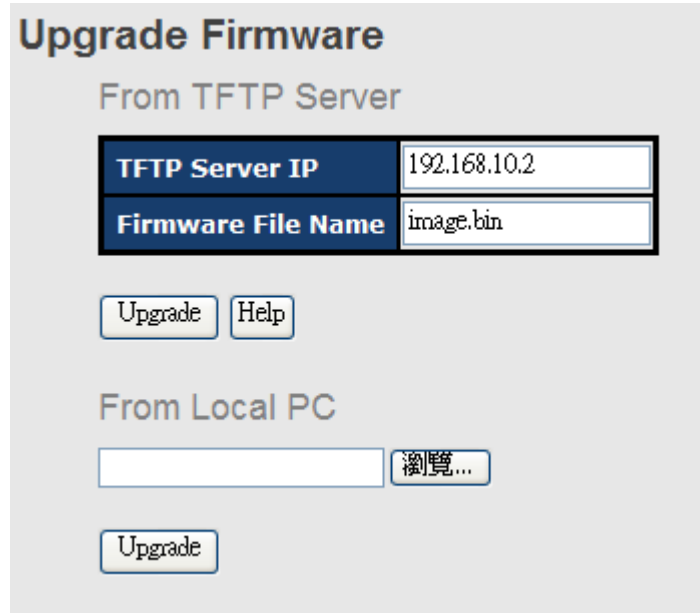

Update Firmware interface

## 5.1.1 Redundancy

### 5.1.1.1 MRP

MRP (Media Redundancy Protocol) Ring (IEC 62439) of up to 50 devices typically transforms back to a line structure within 80 ms (adjustable to max. 200 ms/500 ms).

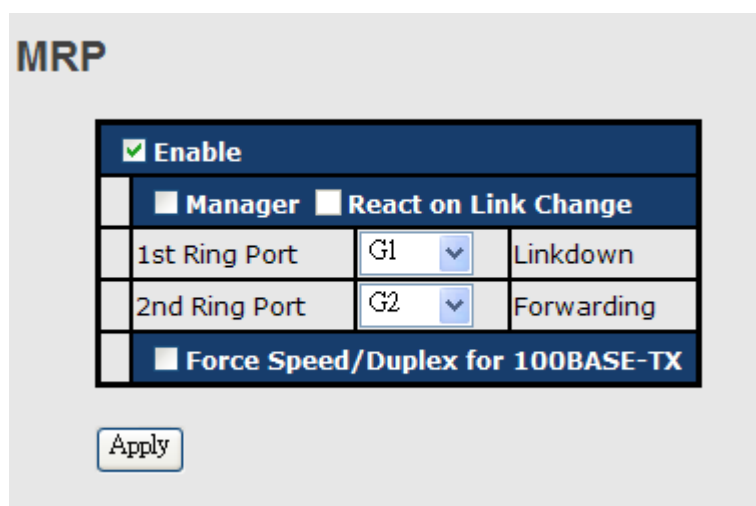

<input checked="" type="checkbox"/>	Enable	
<input type="checkbox"/>	Manager <input type="checkbox"/> React on Link Change	
	1st Ring Port	G1 <input type="button" value="v"/>
		Linkdown
	2nd Ring Port	G2 <input type="button" value="v"/>
		Forwarding
<input checked="" type="checkbox"/>	Force Speed/Duplex for 100BASE-TX	

Label	Description
-------	-------------

<b>Enable</b>	Enabling the MRP function
<b>Manager</b>	MRP Master , every one MRP topology , need setting one device to Manager.(one MRP topology only can setting one device to Manager, if user setting two or more switch to Manager, this MRP topology will fail. )
<b>React on Link Change (Advanced mode)</b>	Faster mode, if user enable this function , MRP Topology will more faster convergence, this function only can setting in MRP Manager Switch.
<b>1<sup>st</sup> Ring Port</b>	Choosing the port which connect to the MRP ring
<b>2<sup>nd</sup> Ring Port</b>	Choosing the port which connect to the MRP ring
<b>Force Speed / Duplex for 100BASE-TX</b>	Port Speed/Duplex default is autonegotiation mode. Enable this function , MRP Ring port Speed/Duplex. Will automatically change to "Full" mode.(this function used in combination Hirschmann Switch MRP , because Hirschmann Switch MRP Ring port speed/duplex always is "Full" mode)

### 5.1.1.2 O-Ring

O-Ring is the most powerful Ring in the world. The recovery time of O-Ring is less than 10 mS. It can reduce unexpected damage caused by network topology change. O-Ring supports three Ring topologies: O-Ring, Coupling Ring and Dual Homing.

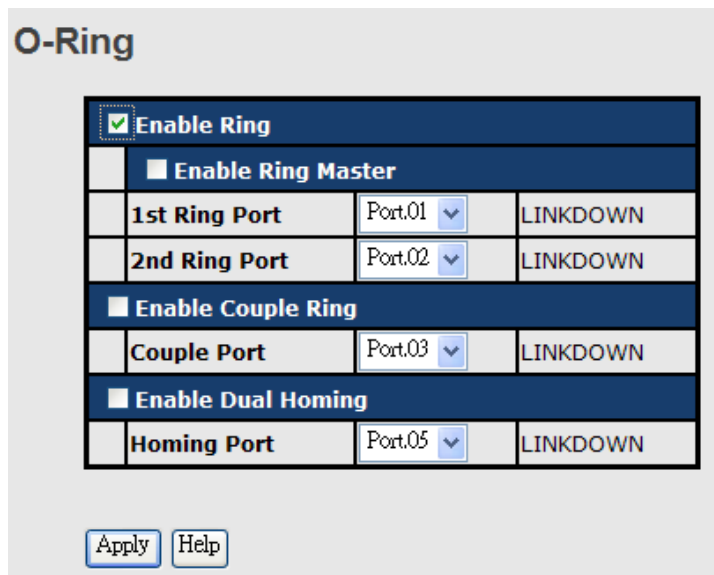

O-Ring interface

The following table describes the labels in this screen.

Label	Description
<b>Enable Ring</b>	Mark to enable Ring.
<b>Enable Ring Master</b>	There should be one and only one Ring Master in a ring.

	However if there are two or more switches which set Ring Master to enable, the switch with the lowest MAC address will be the actual Ring Master and others will be Backup Masters.
<b>1<sup>st</sup> Ring Port</b>	The primary port, when this switch is Ring Master.
<b>2<sup>nd</sup> Ring Port</b>	The backup port, when this switch is Ring Master.
<b>Enable Coupling Ring</b>	Mark to enable Coupling Ring. Coupling Ring can be used to divide a big ring into two smaller rings to avoid effecting all switches when network topology change. It is a good application for connecting two Rings.
<b>Coupling Port</b>	Link to Coupling Port of the switch in another ring. Coupling Ring need four switch to build an active and a backup link. Set a port as coupling port. The coupled four ports of four switches will be run at active/backup mode.
<b>Control Port</b>	Link to Control Port of the switch in the same ring. Control Port used to transmit control signals.
<b>Enable Dual Homing</b>	Mark to enable Dual Homing. By selecting Dual Homing mode, O-Ring will be connected to normal switches through two RSTP links (ex: backbone Switch). The two links work as active/backup mode, and connect each O-Ring to the normal switches in RSTP mode.
<b>Apply</b>	Click "Apply" to set the configurations.

**Note:** We don't suggest you to set one switch as a Ring Master and a Coupling Ring at the same time due to heavy load.

### 5.1.1.3 OPEN-Ring

Open-Ring technology can be applied for other vendor's proprietary ring. Thus, you can add switches of ORing into the network constructed by other ring technology and enable Open-Ring to co-operate with other vendor's managed switch.

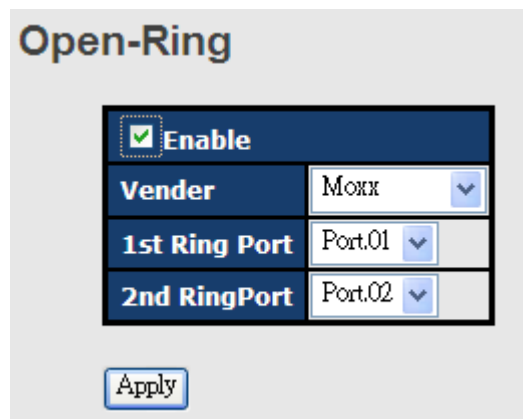

**Open-Ring**

<input checked="" type="checkbox"/> <b>Enable</b>	
<b>Vender</b>	MORXX
<b>1st Ring Port</b>	Port.01
<b>2nd RingPort</b>	Port.02

Apply



## Open-Ring interface

Label	Description
Enable	Enabling the Open-Ring function
Vender	Choosing the venders that you want to join to their ring
1 <sup>st</sup> Ring Port	Choosing the port which connect to the ring
2 <sup>nd</sup> Ring Port	Choosing the port which connect to the ring

The application of Open-Ring is shown as below.

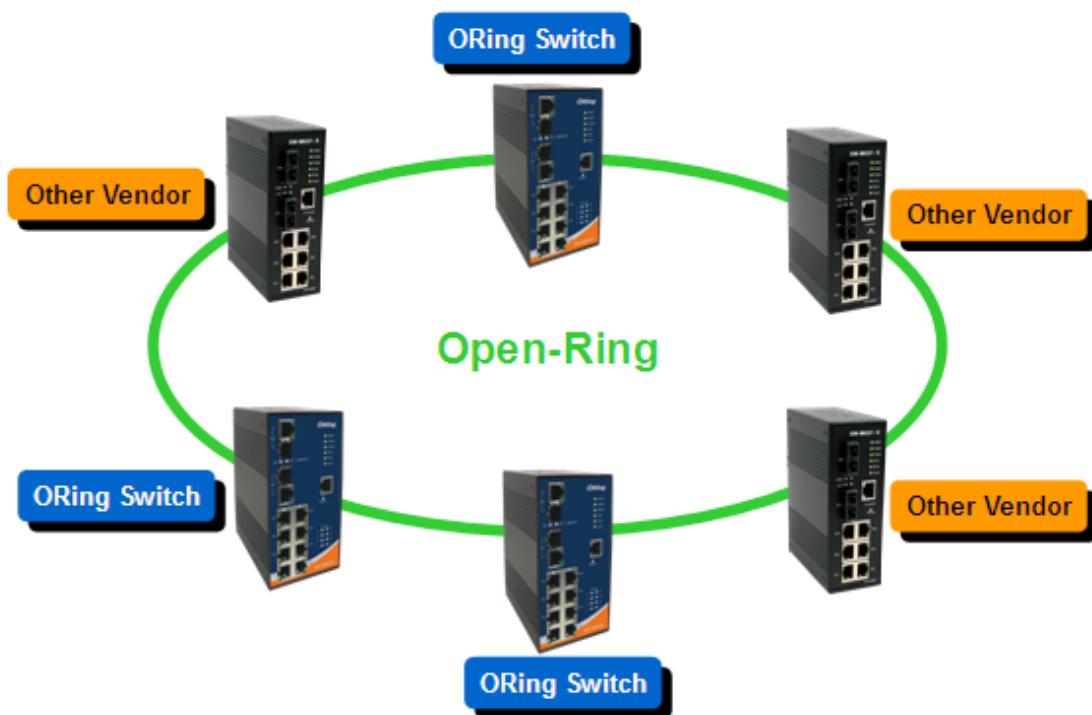

Open-Ring connection

#### 5.1.1.4 O-Chain

O-Chain is the revolutionary network redundancy technology that provides the add-on network redundancy topology for any backbone network, providing ease-of-use while maximizing fault-recovery swiftness, flexibility, compatibility, and cost-effectiveness in one set of network redundancy topologies O-Chain allows multiple redundant network rings of different redundancy protocols to join and function together as a larger and more robust compound network topology, i.e. the creation of multiple redundant networks beyond the limitations of current redundant ring technology.

### O-Chain

<input checked="" type="checkbox"/> Enable			
	Uplink Port	Edge Port	State
1st	Port.01	<input type="checkbox"/>	Linkdown
2nd	Port.02	<input type="checkbox"/>	Forwarding

Label	Description
<b>Enable</b>	Enabling the O-Chain function
<b>1<sup>st</sup> Ring Port</b>	Choosing the port which connect to the ring
<b>2<sup>nd</sup> Ring Port</b>	Choosing the port which connect to the ring
<b>Edge Port</b>	In the O-Chain application, the head and tail of two Switch Port, must start the Edge,MAC smaller Switch, Edge port will be the backup and RM LED Light.

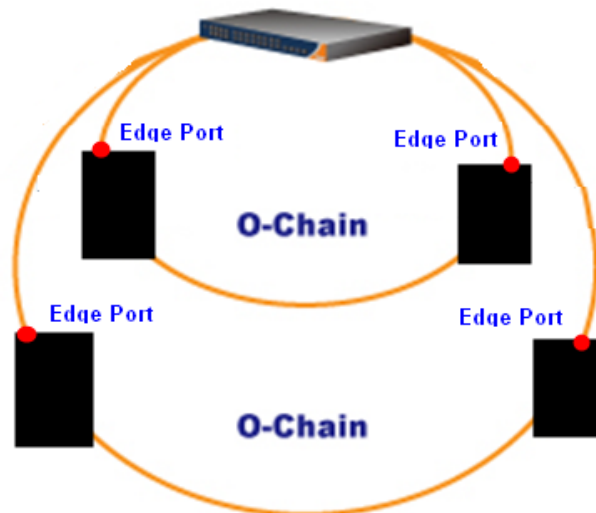

#### 5.1.1.5 RSTP – Repeater

RSTP-Repeater is a simple function , this function can direct pass RSTP BPDU packet , like two RSTP devices connected..

### RSTP-Repeater

<input type="checkbox"/> Enable		
	<b>Uplink Port</b>	<b>RSTP Edge Port</b>
<b>1st</b>	Port.01 ▼	<input type="checkbox"/>
<b>2nd</b>	Port.02 ▼	<input type="checkbox"/>

Label	Description
<b>Enable</b>	Check this box to enable RSTP-Repeater.
<b>1<sup>st</sup> Ring Port</b>	Choosing the port which connect to the RSTP
<b>2<sup>nd</sup> Ring Port</b>	Choosing the port which connect to the RSTP
<b>Edge Port</b>	Only the edge device (connected to RSTP device) needs to specify edge port. The user must specify the edge port according to topology of network.

#### 5.1.1.6 Fast Recovery

The Fast Recovery Mode can be set to connect multiple ports to one or more switches. The TES-250-M12 with its fast recovery mode will provide redundant links. Fast Recovery mode supports 5 priorities, only the first priority will be the act port, the other ports configured with other priority will be the backup ports.

### Fast Recovery Mode

<input checked="" type="checkbox"/> Active	
<b>Port.01</b>	Not included ▼
<b>Port.02</b>	Not included ▼
<b>Port.03</b>	Not included ▼
<b>Port.04</b>	Not included ▼
<b>Port.05</b>	Not included ▼

Fast Recovery Mode interface

The following table describes the labels in this screen.

Label	Description
<b>Active</b>	Activate the fast recovery mode.
<b>port</b>	Port can be configured as 5 priorities. Only the port with highest

	priority will be the active port. 1st Priority is the highest.
<b>Apply</b>	Click " <b>Apply</b> " to activate the configurations.

### 5.1.1.7 RSTP

The Rapid Spanning Tree Protocol (RSTP) is an evolution of the Spanning Tree Protocol. It provides faster spanning tree convergence after a topology change. The system also supports STP and the system will auto detect the connected device that is running STP or RSTP protocol.

#### RSTP setting

You can enable/disable RSTP function, and set parameters for each port.

### RSTP - Bridge Setting

<b>RSTP Mode</b>	Enable <input type="button" value="v"/>
<b>Priority (0-61440)</b>	<input type="text" value="32768"/>
<b>Max Age (6-40)</b>	<input type="text" value="20"/>
<b>Hello Time (1-10)</b>	<input type="text" value="2"/>
<b>Forward Delay Time (4-30)</b>	<input type="text" value="15"/>

**Priority must be a multiple of 4096.**  
**2\*(Forward Delay Time-1) should be greater than or equal to the Max Age.**  
**The Max Age should be greater than or equal to 2\*(Hello Time + 1).**

RSTP Setting interface

The following table describes the labels in this screen.

Label	Description
<b>RSTP mode</b>	You must enable or disable RSTP function before configuring the related parameters.
<b>Priority (0-61440)</b>	A value used to identify the root bridge. The bridge with the lowest value has the highest priority and is selected as the root. If the value changes, You must reboot the switch. The value must be multiple of 4096 according to the protocol standard rule.
<b>Max Age Time(6-40)</b>	The number of seconds a bridge waits without receiving Spanning-tree Protocol configuration messages before attempting a reconfiguration. Enter a value between 6 through 40.



<b>Hello Time (1-10)</b>	The time that controls switch sends out the BPDU packet to check RSTP current status. Enter a value between 1 through 10.
<b>Forwarding Delay Time (4-30)</b>	The number of seconds a port waits before changing from its Rapid Spanning-Tree Protocol learning and listening states to the forwarding state. Enter a value between 4 through 30.
<b>Apply</b>	Click " <b>Apply</b> " to set the configurations.

**NOTE:** Follow the rule to configure the MAX Age, Hello Time, and Forward Delay Time.

$$2 \times (\text{Forward Delay Time value} - 1) \geq \text{Max Age value} \geq 2 \times (\text{Hello Time value} + 1)$$

Show RSTP algorithm result at this table

### Root Bridge Information

<b>Bridge ID</b>	8000001E94011E7A
<b>Root Priority</b>	32768
<b>Root Port</b>	ROOT
<b>Root Path Cost</b>	0
<b>Max Age</b>	20
<b>Hello Time</b>	2
<b>Forward Delay</b>	15

### RSTP - Port Setting

Port	Path Cost (1-20000000)	Priority (0-240)	Admin P2P	Admin Edge	Admin Non Stp
Port.01 Port.02 Port.03 Port.04 Port.05	200000	128	auto	true	false

**priority must be a multiple of 16**

Apply Help

### Port Status

Port	Path Cost	Port Priority	Oper P2P	Oper Edge	Stp Neighbor	State	Role
Port.01	200000	128	True	True	False	Disabled	Disabled
Port.02	200000	128	True	True	False	Disabled	Disabled
Port.03	200000	128	True	True	False	Disabled	Disabled
Port.04	200000	128	True	True	False	Disabled	Disabled
Port.05	200000	128	True	True	False	Disabled	Disabled



Label	Description
<b>Path Cost (1-200000000)</b>	The cost of the path to the other bridge from this transmitting bridge at the specified port. Enter a number 1 through 200000000.
<b>Port Priority (0-240)</b>	Decide which port should be blocked by priority in LAN. Enter a number 0 through 240. The value of priority must be the multiple of 16
<b>Admin P2P</b>	Some of the rapid state transactions that are possible within RSTP are dependent upon whether the port concerned can only be connected to exactly one other bridge (i.e. It is served by a point-to-point LAN segment), or it can be connected to two or more bridges (i.e. It is served by a shared medium LAN segment). This function allows the P2P status of the link to be manipulated administratively. True means P2P enabling. False means P2P disabling.
<b>Admin Edge</b>	The port directly connected to end stations, and it cannot create bridging loop in the network. To configure the port as an edge port, set the port to <b>"True"</b> .
<b>Admin Non STP</b>	The port includes the STP mathematic calculation. <b>True</b> is not including STP mathematic calculation. <b>False</b> is including the STP mathematic calculation.
<b>Apply</b>	Click <b>"Apply"</b> to set the configurations.

#### 5.1.1.8 MSTP

Multiple Spanning Tree Protocol (MSTP) is a standard protocol base on IEEE 802.1s. The function is that several VLANs can be mapping to a reduced number of spanning tree instances because most networks do not need more than a few logical topologies. It supports load balancing scheme and the CPU is sparer than PVST (Cisco proprietary technology).

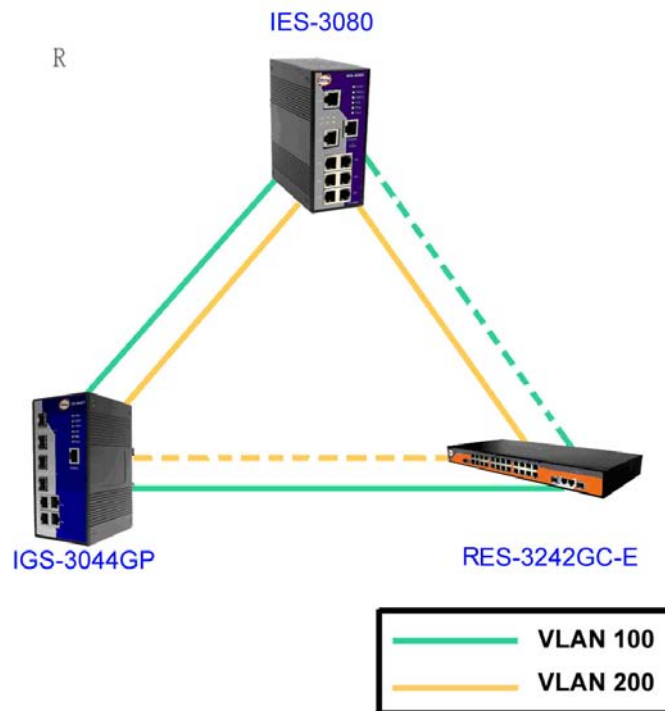

### MSTP - Bridge Setting

<b>MSTP Enable</b>	Enable <input type="button" value="v"/>
<b>Force Version</b>	MSTP <input type="button" value="v"/>
<b>Configuration Name</b>	MSTP_SWITCH
<b>Revision Level (0-65535)</b>	0
<b>Priority (0-61440)</b>	32768
<b>Max Age Time (6-40)</b>	20
<b>Hello Time (1-10)</b>	2
<b>Forward Delay Time (4-30)</b>	15
<b>Max Hops (1-40)</b>	20

Priority must be a multiple of 4096.  
 $2 * (\text{Forward Delay Time} - 1)$  should be greater than or equal to the Max Age.  
 The Max Age should be greater than or equal to  $2 * (\text{Hello Time} + 1)$ .

MSTP Setting interface



The following table describes the labels in this screen.

Label	Description
<b>MSTP Enable</b>	You must enable or disable MSTP function before configuring the related parameters.
<b>Force Version</b>	The Force Version parameter can be used to force a VLAN Bridge that supports RSTP to operate in an STP-compatible manner.
<b>Configuration Name</b>	The same MST Region must have the same MST configuration name.
<b>Revision Level (0-65535)</b>	The same MST Region must have the same revision level.
<b>Priority (0-61440)</b>	A value used to identify the root bridge. The bridge with the lowest value has the highest priority and is selected as the root. If the value changes, You must reboot the switch. The value must be multiple of 4096 according to the protocol standard rule.
<b>Max Age Time(6-40)</b>	The number of seconds a bridge waits without receiving Spanning-tree Protocol configuration messages before attempting a reconfiguration. Enter a value between 6 through 40.
<b>Hello Time (1-10)</b>	The setting follow the rule below to configure the MAX Age, Hello Time, and Forward Delay Time at controlled switch sends out the BPDU packet to check RSTP current status. Enter a value between 1 through 10. $2 \times (\text{Forward Delay Time value} - 1) \geq \text{Max Age value} \geq 2 \times (\text{Hello Time value} + 1)$
<b>Forwarding Delay Time (4-30)</b>	The number of seconds a port waits before changing from its Rapid Spanning-Tree Protocol learning and listening states to the forwarding state. Enter a value between 4 through 30.
<b>Max Hops (1-40)</b>	This parameter is additional to those specified for RSTP. A single value applies to all Spanning Trees within an MST Region (the CIST and all MSTIs) for which the Bridge is the Regional Root.
<b>Apply</b>	Click " <b>Apply</b> " to activate the configurations.



## MSTP - Bridge Port

Port No.	Priority (0-240)	Path Cost (1-200000000, 0:Auto)	Admin P2P	Admin Edge	Admin Non Stp
Port.01 <input type="button" value="▲"/> Port.02 <input type="button" value="☰"/> Port.03 <input type="button" value="▼"/> Port.04 <input type="button" value="▼"/> Port.05 <input type="button" value="▼"/>	128	0	auto <input type="button" value="▼"/>	true <input type="button" value="▼"/>	false <input type="button" value="▼"/>

priority must be a multiple of 16

MSTP Port interface

Label	Description
<b>Port No.</b>	Selecting the port that you want to configure.
<b>Priority (0-240)</b>	Decide which port should be blocked by priority in LAN. Enter a number 0 through 240. The value of priority must be the multiple of 16
<b>Path Cost (1-200000000)</b>	The cost of the path to the other bridge from this transmitting bridge at the specified port. Enter a number 1 through 200000000.
<b>Admin P2P</b>	Some of the rapid state transactions that are possible within RSTP are dependent upon whether the port concerned can only be connected to exactly one other bridge (i.e. It is served by a point-to-point LAN segment), or it can be connected to two or more bridges (i.e. It is served by a shared medium LAN segment). This function allows the P2P status of the link to be manipulated administratively. True means P2P enabling. False means P2P disabling.
<b>Admin Edge</b>	Label
<b>Admin Non STP</b>	Label
<b>Apply</b>	Click " <b>Apply</b> " to activate the configurations.

## MSTP - Instance Setting

Instance	State	VLANs	Priority (0-61440)
1	Enable	1-4094	32768

Priority must be a multiple of 4096.

Apply

MSTP Instance interface

Label	Description
<b>Instance</b>	Set the instance from 1 to 15
<b>State</b>	Enable or disable the instance
<b>VLANs</b>	Set which VLAN will belong which instance
<b>Proprietary (0-61440)</b>	A value used to identify the root bridge. The bridge with the lowest value has the highest priority and is selected as the root. If the value changes, You must reboot the switch. The value must be multiple of 4096 according to the protocol standard rule.
<b>Apply</b>	Click " <b>Apply</b> " to activate the configurations.

## MSTP - Instance Port

Instance: CIST

Port	Priority (0-240)	Path Cost (1-200000000, 0:Auto)
Port.01		
Port.02		
Port.03	128	0
Port.04		
Port.05		

Priority must be a multiple of 16

Apply

MSTP Instance Port interface

Label	Description
<b>Instance</b>	Set the instance's information except CIST
<b>Port</b>	Selecting the port that you want to configure.
<b>Priority (0-240)</b>	Decide which port should be blocked by priority in LAN. Enter a number 0 through 240. The value of priority must be the multiple



	of 16
<b>Path Cost (1-200000000)</b>	The cost of the path to the other bridge from this transmitting bridge at the specified port. Enter a number 1 through 200000000.
<b>Apply</b>	Click " <b>Apply</b> " to set the configurations.

## 5.1.2 Multicast

### 5.1.2.1 IGMP Snooping

Internet Group Management Protocol (IGMP) is used by IP hosts to register their dynamic multicast group membership. IGMP has 3 versions, IGMP v1, v2 and v3. Please refer to RFC 1112, 2236 and 3376. IGMP Snooping improves the performance of networks that carry multicast traffic. It provides the ability to prune multicast traffic so that it travels only to those end destinations that require that traffic and reduces the amount of traffic on the Ethernet LAN.

### IGMP Snooping

IGMP Snooping :

IGMP Query Mode:

#### IGMP Snooping Table

IP Address	VLAN ID	Member Port
230.0.0.20	1	Port.07

#### IGMP Snooping interface

The following table describes the labels in this screen.

Label	Description
<b>IGMP Snooping Table</b>	Show current IP multicast list
<b>IGMP Protocol</b>	Enable/Disable IGMP snooping.
<b>IGMP Query</b>	Switch will be IGMP querier or not. There should exist one and only one IGMP querier in an IGMP application. The "Auto" mode means that the querier is the one with lower IP address.
<b>Apply</b>	Click " <b>Apply</b> " to set the configurations.
<b>Help</b>	Show help file.

#### 5.1.2.2 MVR

MVR Function can provide a different VLAN users to receive MVR Mode VLAN Multicast Packet.

**MVR**

MVR Mode:  ▾

MVR VLAN:

Port	Type	Immediate Leave
Port.01	<input type="text" value="Inactive"/> ▾	<input type="checkbox"/>
Port.02	<input type="text" value="Inactive"/> ▾	<input type="checkbox"/>
Port.03	<input type="text" value="Inactive"/> ▾	<input type="checkbox"/>
Port.04	<input type="text" value="Inactive"/> ▾	<input type="checkbox"/>
Port.05	<input type="text" value="Inactive"/> ▾	<input type="checkbox"/>
Port.06	<input type="text" value="Inactive"/> ▾	<input type="checkbox"/>
Port.07	<input type="text" value="Inactive"/> ▾	<input type="checkbox"/>

Label	Description
<b>MVR Mode</b>	Enable or Disable MVR Mode
<b>MVR VLAN</b>	Setting MVR VLAN
<b>TYPE</b>	Setting Port Type to inactive · Receiver · Source
<b>Immediate Leave</b>	Enable or disable Immediate leave

### 5.1.2.3 Static Multicast Filtering

Static Multicast filtering is the system by which end stations only receive multicast traffic if they register to join specific multicast groups. With multicast filtering, network devices only forward

multicast traffic to the ports that are connected to registered end stations.

### Static Multicast Filtering

Multicast IP Address :

Member Ports :

Port.01  
  Port.02  
  Port.03  
  Port.04  
 Port.05  
  Port.06  
  Port.07  
  Port.08  
 G1  
  G2

	IP Address	Member Ports
<input type="checkbox"/>	230.0.0.6	Port.04, Port.05

#### Multicast Filtering Interface

The following table describes the labels in this screen.

Label	Description
<b>IP Address</b>	Assign a multicast group IP address in the range of 224.0.0.0 ~ 239.255.255.255
<b>Member Ports</b>	Tick the check box beside the port number to include them as the member ports in the specific multicast group IP address.
<b>Add</b>	Show current IP multicast list
<b>Delete</b>	Delete an entry from table
<b>Help</b>	Show help file.

## 5.1.3 Port Setting

### 5.1.3.1 Port Control

By this function, you can set the state, speed/duplex, flow control, and security of the port.

### Port Control

Port No.	State	Speed/Duplex	Flow Control	Security
Port.01	Enable ▾	AutoNegotiation ▾	Symmetric ▾	Disable ▾
Port.02	Enable ▾	AutoNegotiation ▾	Symmetric ▾	Disable ▾
Port.03	Enable ▾	AutoNegotiation ▾	Symmetric ▾	Disable ▾
Port.04	Enable ▾	AutoNegotiation ▾	Symmetric ▾	Disable ▾
Port.05	Enable ▾	AutoNegotiation ▾	Symmetric ▾	Disable ▾
Port.06	Enable ▾	AutoNegotiation ▾	Symmetric ▾	Disable ▾
Port.07	Enable ▾	AutoNegotiation ▾	Symmetric ▾	Disable ▾
Port.08	Enable ▾	AutoNegotiation ▾	Symmetric ▾	Disable ▾
G1	Enable ▾	AutoNegotiation ▾	Symmetric ▾	Disable ▾
G2	Enable ▾	AutoNegotiation ▾	Symmetric ▾	Disable ▾

**Auto Detect 100/1000 SFP** Enable ▾

Port Control interface

The following table describes the labels in this screen.

Label	Description
<b>Port NO.</b>	Port number for setting.
<b>State</b>	Enable/Disable the port.
<b>Speed/Duplex</b>	You can set Auto-negotiation, 100-full, 100-half, 10-full, 10-half mode.
<b>Flow Control</b>	Support symmetric and asymmetric mode to avoid packet loss when congestion occurred.
<b>Security</b>	Enabled port security will disable MAC address learning in this port. Thus only the frames with MAC addresses in port security list will be forwarded, otherwise will be discarded.
<b>Auto Detect 100/1000</b>	Auto Detect SFP port SFP Module speed (100M / 1000M)
<b>Apply</b>	Click " <b>Apply</b> " to activate the configurations.

### 5.1.3.2 Port Status

The following information provides the current port status information

## Port Status

Port No.	Type	Link	State	Speed/Duplex	Flow Control
Port.01	100TX	Down	Enable	N/A	N/A
Port.02	100TX	Down	Enable	N/A	N/A
Port.03	100TX	Down	Enable	N/A	N/A
Port.04	100TX	Down	Enable	N/A	N/A

Port Status interface

### 5.1.3.3 Port Alias

The user can define the name of every Ports. Can let user, convenient management every Port.

## Port Alias

Port No.	Port Alias
Port.01	
Port.02	
Port.03	
Port.04	
Port.05	

### 5.1.3.4 Rate Limit

By this function, you can limit traffic of all ports, including broadcast, multicast and flooded unicast. You can also set "Ingress" or "Egress" to limit traffic received or transmitted bandwidth.



## Rate Limit

Port No.	Ingress Limit Frame Type	Ingress	Egress
Port.01	All	0 kbps	0 kbps
Port.02	All	0 kbps	0 kbps
Port.03	All	0 kbps	0 kbps
Port.04	All	0 kbps	0 kbps
Port.05	All	0 kbps	0 kbps
Port.06	All	0 kbps	0 kbps
Port.07	All	0 kbps	0 kbps
Port.08	All	0 kbps	0 kbps
G1	All	0 kbps	0 kbps
G2	All	0 kbps	0 kbps

Note: rate range is from 100 kbps to 102400 kbps (i.e. 100Mbps) for mega-ports, or 256000 kbps (i.e. 250Mbps) for giga-ports. Zero means no limit.

Apply Help

Rate Limit interface

The following table describes the labels in this screen.

Label	Description
<b>Ingress Limit Frame Type</b>	You can set "all", "Broadcast only", "Broadcast/Multicast" or "Broadcast/Multicast/Flooded Unicast" mode.
<b>Ingress</b>	The switch port received traffic.
<b>Egress</b>	The switch port transmitted traffic.
<b>Apply</b>	Click "Apply" to activate the configurations.

### 5.1.3.5 Port Trunk

#### Port Trunk – Setting

You can select static trunk or 802.3ad LACP to combine several physical links with a logical link to increase the bandwidth.

## Port Trunk - Setting

Port No.	Group ID	Type
Port.01	None	Static
Port.02	None	Static
Port.03	None	Static
Port.04	None	Static
Port.05	None	Static
Port.06	None	Static
Port.07	None	Static
Port.08	None	Static
G1	None	Static
G2	None	Static

Note: the types should be the same for all member ports in a group.

## 802.3ad LACP Work Ports

Group ID	Work Ports
Trunk1	max
Trunk2	max
Trunk3	max
Trunk4	max
Trunk5	max

Apply Help

Port Trunk - Setting interface

The following table describes the labels in this screen.

Label	Description
<b>Group ID</b>	Select port to join a trunk group.
<b>Type</b>	Support static trunk and 802.3ad LACP
<b>Work Port</b>	Select the number of active ports in dynamic group (LACP). The default value of works ports is maximum number of the group. If the number is not maximum number of ports, the

	other inactive ports in dynamic group will be suspended (no traffic). Once the active port is broken, the suspended port will be active automatically.
<b>Apply</b>	Click " <b>Apply</b> " to set the configurations.

### Port Trunk – Status

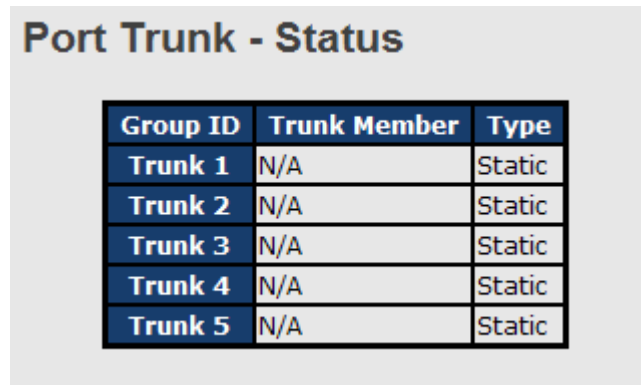

Group ID	Trunk Member	Type
Trunk 1	N/A	Static
Trunk 2	N/A	Static
Trunk 3	N/A	Static
Trunk 4	N/A	Static
Trunk 5	N/A	Static

Port Trunk - Status interface

Label	Description
<b>Group Key</b>	Trunk Group number
<b>Port Member</b>	Show Group port info

### 5.1.3.6 Loop Guard

This feature prevents the loop attack, When the port receives loop packet. This port will auto disable , prevent the "loop attack" affect other network devices

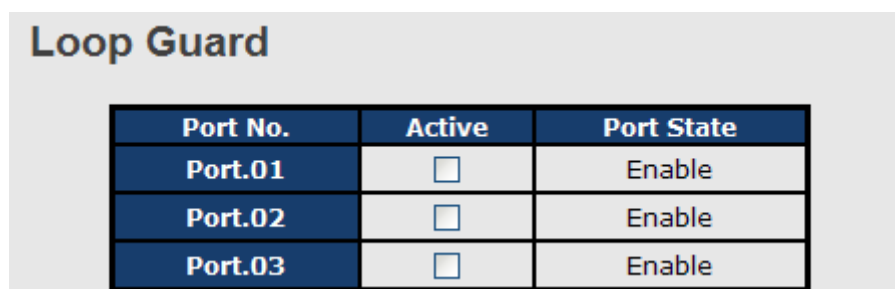

Port No.	Active	Port State
Port.01	<input type="checkbox"/>	Enable
Port.02	<input type="checkbox"/>	Enable
Port.03	<input type="checkbox"/>	Enable

Label	Description
<b>Active</b>	Loop Guard Enable or Disable
<b>Port Status</b>	Port work status.

## 5.1.4 VLAN

A Virtual LAN (VLAN) is a logical network grouping that limits the broadcast domain, which allows you to isolate network traffic. Only the members of the VLAN will receive traffic from the same members of VLAN. Basically, creating a VLAN from a switch is logically equivalent of reconnecting a group of network devices to another Layer 2 switch. However, all the network devices are still plugged into the same switch physically.

The switch supports port-based and 802.1Q (tagged-based) VLAN. The default configuration of VLAN operation mode is at “802.1Q”.

### 5.1.4.1 VLAN Setting - IEEE 802.1Q

Tagged-based VLAN is an IEEE 802.1Q specification standard, and it is possible to create a VLAN across devices from different switch vendors. IEEE 802.1Q VLAN uses a technique to insert a “tag” into the Ethernet frames. Tag contains a VLAN Identifier (VID) that indicates the VLAN numbers.

You can create Tag-based VLAN, and enable or disable GVRP protocol. There are 256 VLAN groups to provide configure. Enable 802.1Q VLAN, the all ports on the switch belong to default VLAN, VID is 1. The default VLAN cannot be deleted.

GVRP allows automatic VLAN configuration between the switch and nodes. If the switch is connected to a device with GVRP enabled, you can send a GVRP request by using the VID of a VLAN defined on the switch; the switch will automatically add that device to the existing VLAN.

### VLAN Setting

VLAN Operation Mode :  ▼

GVRP Mode :  ▼

Management VLAN ID :

#### Port VLAN Setting

Port No.	Link Type	PVID	Untagged VIDs	Tagged VIDs
Port.01	Access ▼	1	1	
Port.02	Access ▼	1	1	
Port.03	Access ▼	1	1	

VLAN Configuration – 802.1Q interface



The following table describes the labels in this screen.

Label	Description
<b>VLAN Operation Mode</b>	Configure VLAN Operation Mode: disable, Port Base,802.1Q
<b>GVRP Mode</b>	Enable/Disable GVRP function.
<b>Management VLAN ID</b>	Management VLAN can provide network administrator a secure VLAN to management Switch. Only the devices in the management VLAN can access the switch.
<b>Port</b>	Select the port to configure.
<b>Link type</b>	There are 3 types of link type: <b>Access Link:</b> single switch only, allows you to group ports by setting the same VID. <b>Trunk Link:</b> extended application of <b>Access Link</b> , allows you to group ports by setting the same VID with 2 or more switches. <b>Hybrid Link:</b> Both <b>Access Link</b> and <b>Trunk Link</b> are available. <b>Hybrid(QinQ) Link:</b> enable QinQ mode , allow you to insert one more VLAN tag in a original VLAN frame.
<b>Untagged VID</b>	Set the port default VLAN ID for untagged devices that connect to the port. The range is 1 to 4094.
<b>Tagged VIDs</b>	Set the tagged VIDs to carry different VLAN frames to other switch.
<b>Apply</b>	Click " <b>Apply</b> " to set the configurations.

#### 5.1.4.2 VLAN Setting – Port Based

Packets can go among only members of the same VLAN group. Note all unselected ports are treated as belonging to another single VLAN. If the port-based VLAN enabled, the VLAN-tagging is ignored.

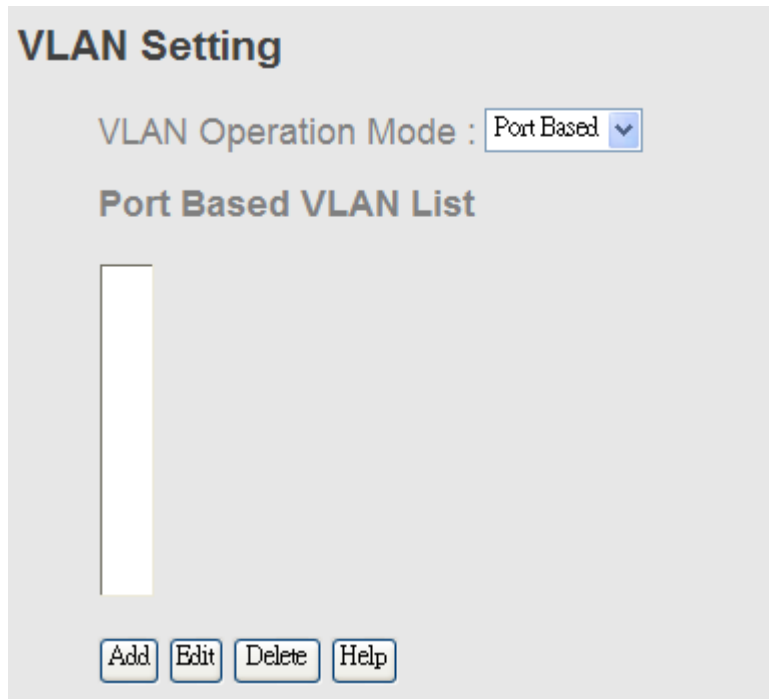

VLAN Configuration – Port Base interface-1

The following table describes the labels in this screen.

Label	Description
<b>Add</b>	Click “ <b>add</b> ” to enter VLAN add interface.
<b>Edit</b>	Edit exist VLAN
<b>Delete</b>	Delete exist VLAN
<b>Help</b>	Show help file.

### VLAN Setting

VLAN Operation Mode :

Group Name:

VLAN ID:

Port.01  
 Port.02  
 Port.03  
 Port.04  
 Port.05  
 Port.06  
 Port.07  
 Port.08  
 G1  
 G2

VLAN Configuration – Port Base interface-2

The following table describes the labels in this screen.

Label	Description
<b>Group Name</b>	VLAN name.
<b>VLAN ID</b>	Specify the VLAN ID
<b>Add</b>	Select port to join the VLAN group.
<b>Remove</b>	Remove port of the VLAN group
<b>Apply</b>	Click " <b>Apply</b> " to set the configurations.
<b>Help</b>	Show help file.

## 5.1.5 Traffic Prioritization

Traffic Prioritization includes 3 modes: port base, 802.1p/COS, and TOS/DSCP. By traffic prioritization function, you can classify the traffic into four classes for differential network application. IGS-3044GP(GC) series support 4 priority queues.

### 5.1.5.1 Qos policy

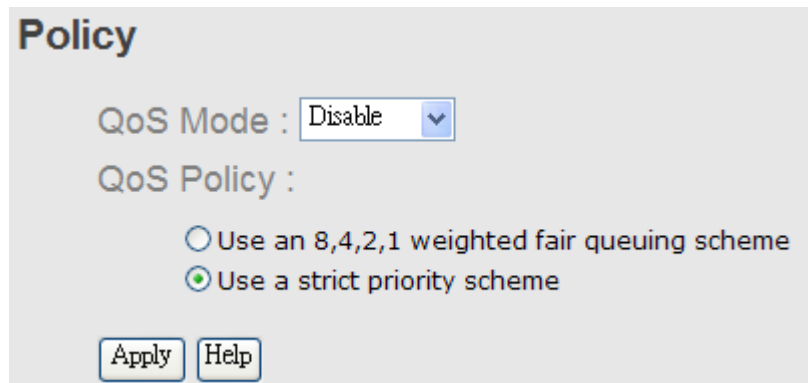

The screenshot shows a configuration window titled "Policy". It contains the following elements:

- QoS Mode :** A dropdown menu currently set to "Disable".
- QoS Policy :** Two radio button options:
  - Use an 8,4,2,1 weighted fair queuing scheme
  - Use a strict priority scheme
- Buttons:** "Apply" and "Help" buttons at the bottom.

Traffic Prioritization interface

The following table describes the labels in this screen.

Label	Description
<b>QOS Mode</b>	<ul style="list-style-type: none"> <li>■ <b>Port-base:</b> the output priority is determined by ingress port.</li> <li>■ <b>COS only:</b> the output priority is determined by COS only.</li> <li>■ <b>TOS only:</b> the output priority is determined by TOS only.</li> <li>■ <b>COS first:</b> the output priority is determined by COS and TOS, but COS first.</li> <li>■ <b>TOS first:</b> the output priority is determined by COS and TOS, but TOS first.</li> </ul>
<b>QOS policy</b>	<ul style="list-style-type: none"> <li>■ <b>Using the 8,4,2,1 weight fair queue scheme:</b> the output queues will follow 8:4:2:1 ratio to transmit packets from the highest to lowest queue. For example: 8 high queue packets, 4 middle queue packets, 2 low queue packets, and the one lowest queue packets are transmitted in one turn.</li> <li>■ <b>Use the strict priority scheme:</b> always the packets in higher queue will be transmitted first until higher queue is empty.</li> </ul>
<b>Apply</b>	Click " <b>Apply</b> " to set the configurations.
<b>Help</b>	Show help file.



### 5.1.5.2 Port-base priority

**Port-based Priority**

Port No.	Priority
Port.01	Lowest
Port.02	Lowest
Port.03	Lowest
Port.04	Lowest
Port.05	Lowest
Port.06	Lowest
Port.07	Lowest
Port.08	Lowest
G1	Lowest
G2	Lowest

Port-based Priority interface

The following table describes the labels in this screen

<b>Port base Priority</b>	Assign Port with a priority queue. 4 priority queues can be assigned: High, Middle, Low, and Lowest.
<b>Apply</b>	Click " <b>Apply</b> " to set the configurations.
<b>Help</b>	Show help file.

### 5.1.5.3 COS/802.1p

**COS/802.1p**

COS	Priority
0	Lowest
1	Lowest
2	Low
3	Low
4	Middle
5	Middle
6	High
7	High

**COS Port Default**

Port No.	COS
Port.01	0
Port.02	0
Port.03	0
Port.04	0
Port.05	0
Port.06	0
Port.07	0
Port.08	0
G1	0
G2	0

COS/802.1p interface

The following table describes the labels in this screen

<b>COS/802.1p</b>	COS (Class Of Service) is well known as 802.1p. It describes that the output priority of a packet is determined by user priority field in 802.1Q VLAN tag. The priority value is supported 0to7. COS value map to 4 priority queues: High, Middle, Low, and Lowest.
<b>COS Port Default</b>	When an ingress packet has not VLAN tag, a default priority value is considered and determined by ingress port.
<b>Apply</b>	Click " <b>Apply</b> " to set the configurations.
<b>Help</b>	Show help file.

#### 5.1.5.4 TOS/DSCP

**TOS/DSCP**

<b>DSCP</b>	<b>0</b>	<b>1</b>	<b>2</b>	<b>3</b>	<b>4</b>	<b>5</b>	<b>6</b>	<b>7</b>
<b>Priority</b>	Lowest ▾	Lowest ▾	Lowest ▾	Lowest ▾	Lowest ▾	Lowest ▾	Lowest ▾	Lowest ▾
<b>DSCP</b>	<b>8</b>	<b>9</b>	<b>10</b>	<b>11</b>	<b>12</b>	<b>13</b>	<b>14</b>	<b>15</b>
<b>Priority</b>	Lowest ▾	Lowest ▾	Lowest ▾	Lowest ▾	Lowest ▾	Lowest ▾	Lowest ▾	Lowest ▾
<b>DSCP</b>	<b>16</b>	<b>17</b>	<b>18</b>	<b>19</b>	<b>20</b>	<b>21</b>	<b>22</b>	<b>23</b>
<b>Priority</b>	Low ▾	Low ▾	Low ▾	Low ▾	Low ▾	Low ▾	Low ▾	Low ▾
<b>DSCP</b>	<b>24</b>	<b>25</b>	<b>26</b>	<b>27</b>	<b>28</b>	<b>29</b>	<b>30</b>	<b>31</b>
<b>Priority</b>	Low ▾	Low ▾	Low ▾	Low ▾	Low ▾	Low ▾	Low ▾	Low ▾
<b>DSCP</b>	<b>32</b>	<b>33</b>	<b>34</b>	<b>35</b>	<b>36</b>	<b>37</b>	<b>38</b>	<b>39</b>
<b>Priority</b>	Middle ▾	Middle ▾	Middle ▾	Middle ▾	Middle ▾	Middle ▾	Middle ▾	Middle ▾
<b>DSCP</b>	<b>40</b>	<b>41</b>	<b>42</b>	<b>43</b>	<b>44</b>	<b>45</b>	<b>46</b>	<b>47</b>
<b>Priority</b>	Middle ▾	Middle ▾	Middle ▾	Middle ▾	Middle ▾	Middle ▾	Middle ▾	Middle ▾
<b>DSCP</b>	<b>48</b>	<b>49</b>	<b>50</b>	<b>51</b>	<b>52</b>	<b>53</b>	<b>54</b>	<b>55</b>
<b>Priority</b>	High ▾	High ▾	High ▾	High ▾	High ▾	High ▾	High ▾	High ▾
<b>DSCP</b>	<b>56</b>	<b>57</b>	<b>58</b>	<b>59</b>	<b>60</b>	<b>61</b>	<b>62</b>	<b>63</b>
<b>Priority</b>	High ▾	High ▾	High ▾	High ▾	High ▾	High ▾	High ▾	High ▾

Apply Help

TOS/DSCP interface

The following table describes the labels in this screen

<b>TOS/DSCP</b>	TOS (Type of Service) is a field in IP header of a packet. This TOS field is also used by Differentiated Services and is called the Differentiated Services Code Point (DSCP). The output priority of a packet can be determined by this field and the priority value is supported 0to63. DSCP value map to 4 priority queues: High, Middle, Low, and Lowest.
<b>Apply</b>	Click " <b>Apply</b> " to set the configurations.
<b>Help</b>	Show help file.

## 5.1.6 DHCP Server

### 5.1.6.1 DHCP Server – Setting

The system provides with DHCP server function. Enable the DHCP server function, the switch system will be a DHCP server.

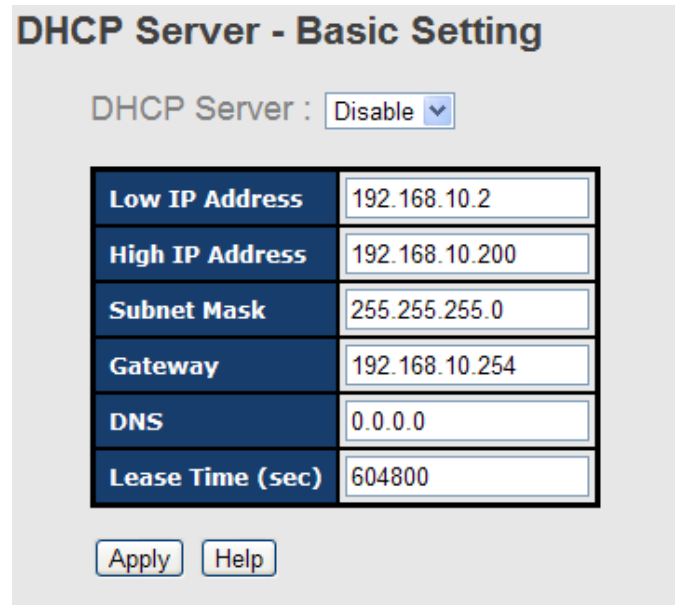

**DHCP Server - Basic Setting**

DHCP Server :  ▾

<b>Low IP Address</b>	<input type="text" value="192.168.10.2"/>
<b>High IP Address</b>	<input type="text" value="192.168.10.200"/>
<b>Subnet Mask</b>	<input type="text" value="255.255.255.0"/>
<b>Gateway</b>	<input type="text" value="192.168.10.254"/>
<b>DNS</b>	<input type="text" value="0.0.0.0"/>
<b>Lease Time (sec)</b>	<input type="text" value="604800"/>

DHCP Server Configuration interface

The following table describes the labels in this screen.

Label	Description
<b>DHCP Server</b>	Enable or Disable the DHCP Server function. Enable – the switch will be the DHCP server on your local network
<b>Start IP Address</b>	The dynamic IP assign range. Low IP address is the beginning of the dynamic IP assigns range. For example: dynamic IP assign range is from 192.168.1.100 to 192.168.1.200. 192.168.1.100 will be the Start IP address.
<b>End IP Address</b>	The dynamic IP assign range. High IP address is the end of the dynamic IP assigns range. For example: dynamic IP assign range is from 192.168.1.100 to 192.168.1.200. 192.168.1.200 will be the End IP address
<b>Subnet Mask</b>	The dynamic IP assign range subnet mask
<b>Gateway</b>	The gateway in your network.
<b>DNS</b>	Domain Name Server IP Address in your network.
<b>Lease Time (Hour)</b>	It is the period that system will reset the assigned dynamic IP to ensure the IP address is in used.
<b>Apply</b>	Click “ <b>Apply</b> ” to set the configurations.

### 5.1.6.2 DHCP Server – Client List

When the DHCP server function is activated, the system will collect the DHCP client information and display in here.

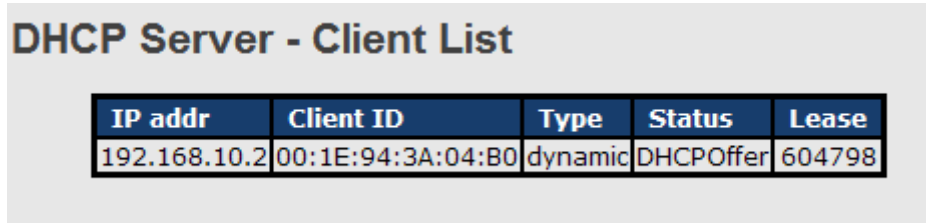

The screenshot shows a table titled "DHCP Server - Client List" with the following data:

IP addr	Client ID	Type	Status	Lease
192.168.10.2	00:1E:94:3A:04:B0	dynamic	DHCPOffer	604798

DHCP Server Client Entries interface

### 5.1.6.3 DHCP Server – Port and IP bindings

You can assign the specific IP address which is in the assigned dynamic IP range to the specific port. When the device is connecting to the port and asks for dynamic IP assigning, the system will assign the IP address that has been assigned before in the connected device.

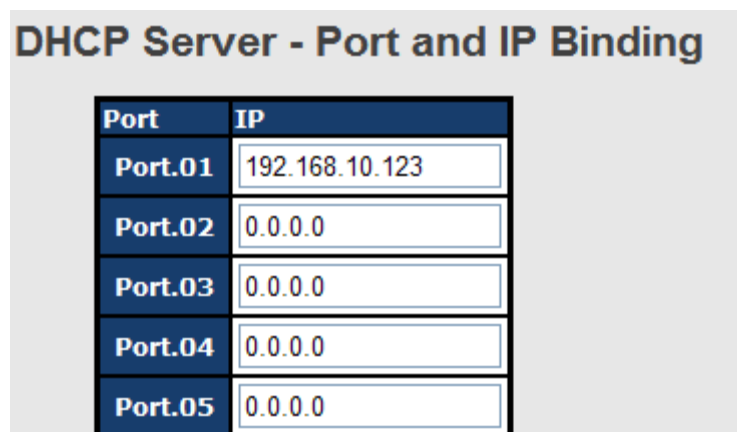

The screenshot shows a table titled "DHCP Server - Port and IP Binding" with the following data:

Port	IP
Port.01	192.168.10.123
Port.02	0.0.0.0
Port.03	0.0.0.0
Port.04	0.0.0.0
Port.05	0.0.0.0

DHCP Server Port and IP Binding interface

### 5.1.6.4 DHCP Server –DHCP Relay Agent

The DHCP relay agent relays DHCP messages between clients and servers for DHCP on different subnet domain. DHCP relay agent use Option 82 to insert specific information into a request that is being forwarded to a DHCP server, and according to Option 82 to remove the specific information from a reply packets when forwarding server DHCP packets to a DHCP client.

## DHCP Relay Agent

 Mode : 

### DHCP Server IP Address

<b>1st Server IP</b>	<input type="text" value="0.0.0.0"/>	<b>VID</b>	<input type="text" value="1"/>
<b>2nd Server IP</b>	<input type="text" value="0.0.0.0"/>	<b>VID</b>	<input type="text" value="1"/>
<b>3rd Server IP</b>	<input type="text" value="0.0.0.0"/>	<b>VID</b>	<input type="text" value="1"/>
<b>4th Server IP</b>	<input type="text" value="0.0.0.0"/>	<b>VID</b>	<input type="text" value="1"/>

### DHCP Option 82 Remote ID

<b>Type</b>	<input type="text" value="IP"/>
<b>Value</b>	<input type="text" value="192.168.10.1"/>
<b>Display</b>	<input type="text" value="COA80A01"/>

### DHCP Option 82 Circuit-ID Table

Port No.	Circuit-ID	Option 82
<b>Port.01</b>	000400010001	<input type="checkbox"/>
<b>Port.02</b>	000400010002	<input type="checkbox"/>
<b>Port.03</b>	000400010003	<input type="checkbox"/>
<b>Port.04</b>	000400010004	<input type="checkbox"/>
<b>Port.05</b>	000400010005	<input type="checkbox"/>
<b>Port.06</b>	000400010006	<input type="checkbox"/>
<b>Port.07</b>	000400010007	<input type="checkbox"/>
<b>Port.08</b>	000400010008	<input type="checkbox"/>
<b>G1</b>	000400010009	<input type="checkbox"/>
<b>G2</b>	00040001000a	<input type="checkbox"/>

The following table describes the labels in this screen.

Label	Description
<b>DHCP Relay</b>	Enable/Disable DHCP Relay Agent.
<b>DHCP Server IP Address and VID</b>	Specify the IP address and VID of DHCP server. Keep "0.0.0.0" means server is inactive.

<b>DHCP Option 82 Remote ID</b>	"Option 82 Remote ID" provides a identifier for the remote server. There are 4 types supported: IP, MAC, Client-ID, and Other.
<b>DHCP Option 82 Circuit-ID Table</b>	"Option 82 Circuit-ID" encodes an agent-local identifier of the circuit from which a DHCP client-to-server packet was received. It is intended for use by agents in relaying DHCP responses back to the proper circuit.
<b>Apply</b>	Click " <b>Apply</b> " to set the configurations.

## 5.1.7 SNMP

Simple Network Management Protocol (SNMP) is the protocol developed to manage nodes (servers, workstations, routers, switches and hubs etc.) on an IP network. SNMP enables network administrators to manage network performance, find and solve network problems, and plan for network growth. Network management systems learn of problems by receiving traps or change notices from network devices implementing SNMP.

### 5.1.7.1 SNMP – Agent Setting

You can set SNMP agent related information by Agent Setting Function.

### SNMP - Agent Setting

SNMP Agent Version SNMPV1/V2c ▼

Apply

#### SNMP V1/V2c Community

Community String	Privilege
<input style="width: 90%;" type="text" value="public"/>	Read Only <span style="font-size: 0.8em;">▼</span>
<input style="width: 90%;" type="text" value="private"/>	Read and Write <span style="font-size: 0.8em;">▼</span>
<input style="width: 90%;" type="text"/>	Read Only <span style="font-size: 0.8em;">▼</span>
<input style="width: 90%;" type="text"/>	Read Only <span style="font-size: 0.8em;">▼</span>

Apply

SNMP – Agent setting interface

The following table describes the labels in this screen.

Label	Description
<b>SNMP agent Version</b>	Three SNMP versions are supported such as SNMP V1/SNMP V2c, and SNMP V3. SNMP V1/SNMP V2c agent use a

	community string match for authentication, that means SNMP servers access objects with read-only or read/write permissions with the community default string public/private. SNMP V3 requires an authentication level of MD5 or DES to encrypt data to enhance data security.
<b>SNMP V1/V2c Community</b>	SNMP Community should be set for SNMP V1/V2c. Four sets of "Community String/Privilege" are supported. Each Community String is maximum 32 characters. Keep empty to remove this Community string.
<b>Apply</b>	Click " <b>Apply</b> " to activate the configurations.
<b>Help</b>	Show help file.

### 5.1.7.2 SNMP –Trap Setting

A trap manager is a management station that receives traps, the system alerts generated by the switch. If no trap manager is defined, no traps will issue. Create a trap manager by entering the IP address of the station and a community string. To define management stations as trap manager and enter SNMP community strings and selects the SNMP version.

#### SNMP - Trap Setting

##### Trap Server Setting

Server IP	<input style="width: 100%;" type="text"/>
Community	<input style="width: 100%;" type="text"/>
Trap Version	<input checked="" type="radio"/> V1 <input type="radio"/> V2c

##### Trap Server Profile

Server IP	Community	Trap Version
(none)		

SNMP –Trap Setting interface



The following table describes the labels in this screen.

Label	Description
<b>Server IP</b>	The server IP address to receive Trap
<b>Community</b>	Community for authentication
<b>Trap Version</b>	Trap Version supports V1 and V2c and V3
<b>Add</b>	Add trap server profile.
<b>Remove</b>	Remove trap server profile.
<b>Help</b>	Show help file.

### 5.1.7.3 SNMPV3

#### NMP - SNMPv3 Setting

SNMPv3 Engine ID: f465000003001e940a002b

##### Context Table

Context Name :	<input type="text"/>	Apply
----------------	----------------------	-------

##### User Table

Current User Profiles :	New User Profile :	
(none)	<input type="button" value="Remove"/>	<input type="button" value="Add"/>
	User ID:	<input type="text"/>
	Authentication Password:	<input type="text"/>
	Privacy Password:	<input type="text"/>

##### Group Table

Current Group content :	New Group Table:	
(none)	<input type="button" value="Remove"/>	<input type="button" value="Add"/>
	Security Name (User ID):	<input type="text"/>
	Group Name:	<input type="text"/>





<b>Current Access Tables :</b> <input type="button" value="Remove"/>		<b>New Access Table :</b> <input type="button" value="Add"/>	
(none)	<b>Context Prefix:</b>	<input type="text"/>	
	<b>Group Name:</b>	<input type="text"/>	
	<b>Security Level:</b>	<input type="radio"/> NoAuthNoPriv. <input type="radio"/> AuthNoPriv. <input type="radio"/> AuthPriv.	
	<b>Context Match Rule</b>	<input type="radio"/> Exact <input type="radio"/> Prefix	
	<b>Read View Name:</b>	<input type="text"/>	
	<b>Write View Name:</b>	<input type="text"/>	
	<b>Notify View Name:</b>	<input type="text"/>	
<b>MIBView Table</b>			
<b>Current MIBTables :</b> <input type="button" value="Remove"/>		<b>New MIBView Table :</b> <input type="button" value="Add"/>	
(none)	<b>View Name:</b>	<input type="text"/>	
	<b>SubOid-Tree:</b>	<input type="text"/>	
	<b>Type:</b>	<input type="radio"/> Excluded <input type="radio"/> Included	
<p><b>Note:</b> Any modification of SNMPv3 tables might cause MIB accessing rejection. Please take notice of the causality between the tables before you modify these tables.</p>			

The following table describes the labels in this screen

Label	Description
<b>Context Table</b>	Configure SNMP v3 context table. Assign the context name of context table. Click "Apply" to change context name
<b>User Table</b>	<ol style="list-style-type: none"> <li>1. Configure SNMP v3 user table.</li> <li>2. <b>User ID:</b> set up the user name.</li> <li>3. <b>Authentication Password:</b> set up the authentication password.</li> <li>4. <b>Privacy Password:</b> set up the private password.</li> <li>5. Click "Add" to add context name.</li> <li>6. Click "Remove" to remove unwanted context name.</li> </ol>
<b>Group Table</b>	<ol style="list-style-type: none"> <li>1. Configure SNMP v3 group table.</li> <li>2. <b>Security Name (User ID):</b> assign the user name that you have set up in user table.</li> <li>3. <b>Group Name:</b> set up the group name.</li> <li>4. Click "Add" to add context name.</li> <li>5. Click "Remove" to remove unwanted context name.</li> </ol>

<b>Access Table</b>	<ol style="list-style-type: none"> <li>1. Configure SNMP v3 access table.</li> <li>2. <b>Context Prefix:</b> set up the context name.</li> <li>3. <b>Group Name:</b> set up the group.</li> <li>4. <b>Security Level:</b> select the access level.</li> <li>5. <b>Context Match Rule:</b> select the context match rule.</li> <li>6. <b>Read View Name:</b> set up the read view.</li> <li>7. <b>Write View Name:</b> set up the write view.</li> <li>8. <b>Notify View Name:</b> set up the notify view.</li> <li>9. Click "Add" to add context name.</li> <li>10. Click "Remove" to remove unwanted context name.</li> </ol>
<b>MIBview Table</b>	<ol style="list-style-type: none"> <li>1. Configure MIB view table.</li> <li>2. <b>ViewName:</b> set up the name.</li> <li>3. <b>Sub-Oid Tree:</b> fill the Sub OID.</li> <li>4. <b>Type:</b> select the type – exclude or included.</li> <li>5. Click "Add" to add context name.</li> <li>6. Click "Remove" to remove unwanted context name.</li> </ol>
<b>Help</b>	Show help file.

## 5.1.8 Security

Five useful functions can enhance security of switch: IP Security, Port Security, MAC Blacklist, and MAC address Aging and 802.1x protocol.

### 5.1.8.1 Management Security

Only IP in the Secure IP List can manage the switch through your defined management mode. (WEB, Telnet, SNMP)

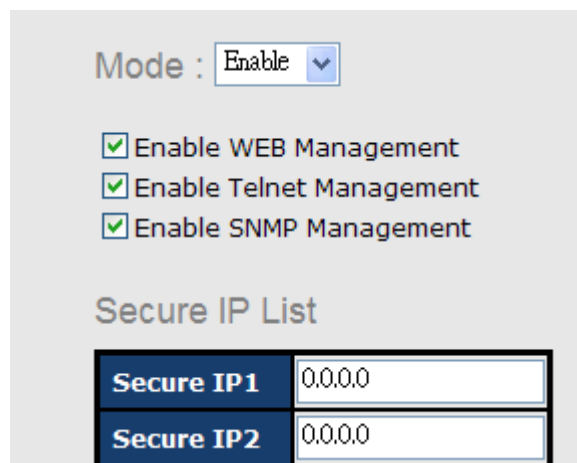

Mode :

Enable WEB Management

Enable Telnet Management

Enable SNMP Management

Secure IP List

Secure IP1	0.0.0.0
Secure IP2	0.0.0.0

IP Security interface

The following table describes the labels in this screen.

Label	Description
<b>IP security MODE</b>	Enable/Disable the IP security function.
<b>Enable WEB Management</b>	Mark the blank to enable WEB Management.
<b>Enable Telnet Management</b>	Mark the blank to enable Telnet Management.
<b>Enable SNMP Management</b>	Mark the blank to enable MPSN Management.
<b>Apply</b>	Click " <b>Apply</b> " to set the configurations.
<b>Help</b>	Show help file.

### 5.1.8.2 Static MAC Forwarding

Static MAC Forwarding is to add static MAC addresses to hardware forwarding database. If port security is enabled at **Port Control** page, only the frames with MAC addresses in this list will be forwarded, otherwise will be discarded.

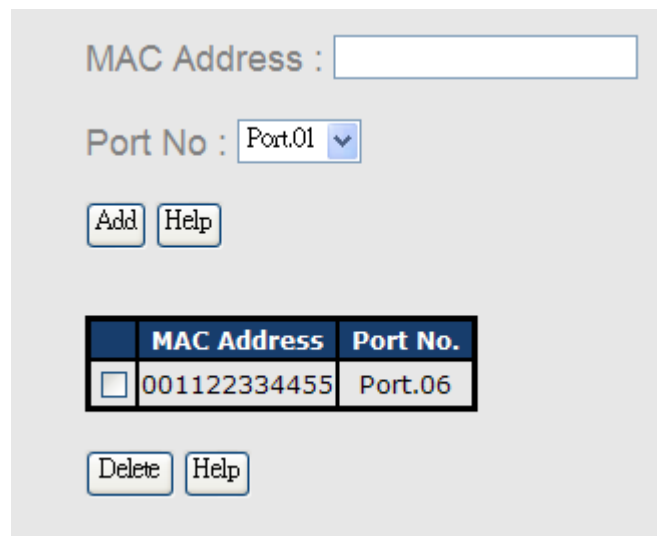

MAC Address :

Port No :

	MAC Address	Port No.
<input type="checkbox"/>	001122334455	Port.06

Port Security interface

The following table describes the labels in this screen.

Label	Description
<b>MAC Address</b>	Input MAC Address to a specific port.
<b>Port NO.</b>	Select port of switch.
<b>Add</b>	Add an entry of MAC and port information.
<b>Delete</b>	Delete the entry.
<b>Help</b>	Show help file.

### 5.1.8.3 MAC Blacklist

MAC Blacklist can eliminate the traffic forwarding to specific MAC addresses in list. Any frames forwarding to MAC addresses in this list will be discarded. Thus the target device will never receive any frame.

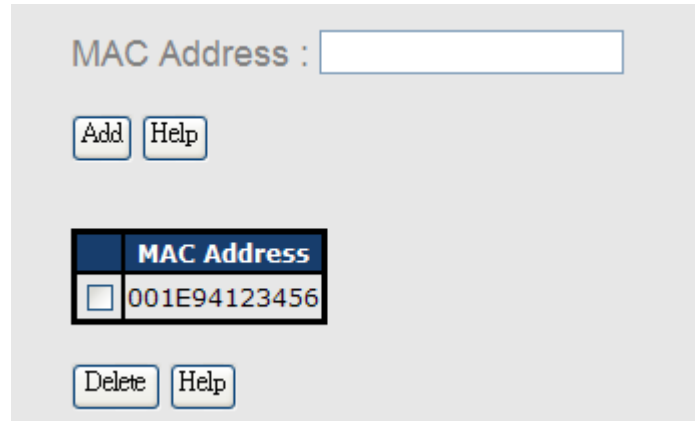

MAC Address
<input type="checkbox"/> 001E94123456

MAC Blacklist interface

The following table describes the labels in this screen.

Label	Description
<b>MAC Address</b>	Input MAC Address to add to MAC Blacklist.
<b>Port NO.</b>	Select port of switch.
<b>Add</b>	Add an entry to Blacklist table.
<b>Delete</b>	Delete the entry.
<b>Help</b>	Show help file.

### 5.1.8.4 802.1x

#### 802.1x - Radius Server

802.1x makes the use of the physical access characteristics of IEEE802 LAN infrastructures in order to provide a authenticated and authorized devices attached to a LAN port. Please refer to IEEE 802.1X - Port Based Network Access Control.

## 802.1x - Radius Server

Radius Server Setting

<b>802.1x Protocol</b>	Enable <input type="button" value="v"/>
<b>Radius Server IP</b>	<input type="text" value="192.168.16.3"/>
<b>Server Port</b>	<input type="text" value="1812"/>
<b>Accounting Port</b>	<input type="text" value="1813"/>
<b>Shared Key</b>	<input type="text" value="12345678"/>
<b>NAS, Identifier</b>	<input type="text" value="NAS_L2_SWITCH"/>

Advanced Setting

<b>Quiet Period</b>	<input type="text" value="60"/>
<b>TX Period</b>	<input type="text" value="30"/>
<b>Supplicant Timeout</b>	<input type="text" value="30"/>
<b>Server Timeout</b>	<input type="text" value="30"/>
<b>Max Requests</b>	<input type="text" value="2"/>
<b>Re-Auth Period</b>	<input type="text" value="3600"/>

802.1x Radius Server interface

The following table describes the labels in this screen.

Label	Description
<b>802.1x Portocol</b>	Enable or Disable 802.1X Radius Server function .
<b>Radius Server IP</b>	The IP address of the authentication server.
<b>Server port</b>	Set the UDP port number used by the authentication server to authenticate.
<b>Account port</b>	Set the UDP destination port for accounting requests to the specified Radius Server.
<b>Shared Key</b>	A key shared between this switch and authentication server.
<b>NAS, Identifier</b>	A string used to identify this switch.
<b>Advanced Setting</b>	
<b>Quiet Period</b>	Set the time interval between authentication failure and the start of a new authentication attempt.
<b>Tx Period</b>	Set the time that the switch can wait for response to an EAP request/identity frame from the client before resending the request.

<b>Supplicant Timeout</b>	Set the period of time the switch waits for a supplicant response to an EAP request.
<b>Server Timeout</b>	Set the period of time the switch waits for a Radius server response to an authentication request.
<b>Max Requests</b>	Set the maximum number of times to retry sending packets to the supplicant.
<b>Re-Auth Period</b>	Set the period of time after which clients connected must be re-authenticated.
<b>Apply</b>	Click " <b>Apply</b> " to set the configurations.
<b>Help</b>	Show help file.

### 802.1x-Port Authorized Mode

Set the 802.1x authorized mode of each port.

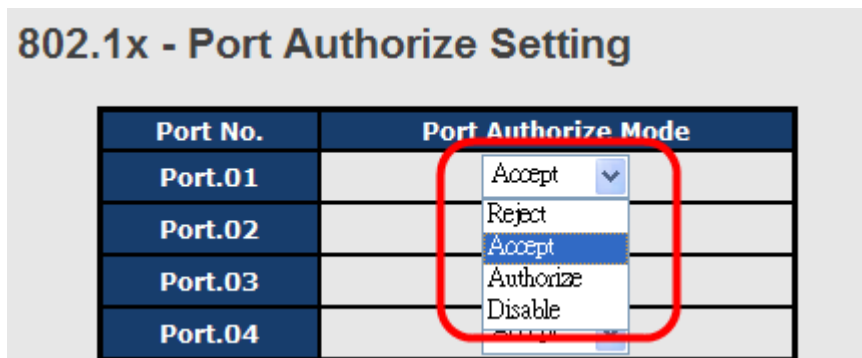

802.1x Port Authorize interface

The following table describes the labels in this screen.

Label	Description
<b>Port Authorized Mode</b>	<ul style="list-style-type: none"> <li>■ <b>Reject:</b> force this port to be unauthorized.</li> <li>■ <b>Accept:</b> force this port to be authorized.</li> <li>■ <b>Authorize:</b> the state of this port was determined by the outcome of the 802.1x authentication.</li> <li>■ <b>Disable:</b> this port will not participate in 802.1x.</li> </ul>
<b>Apply</b>	Click " <b>Apply</b> " to set the configurations.
<b>Help</b>	Show help file.

### 802.1x-Port Authorized Mode

Show 802.1x port authorized state.

802.1x - Port Authorize State	
Port No.	Port Authorize State
Port.01	Accept
Port.02	Accept
Port.03	Accept
Port.04	Accept
Port.05	Accept
Port.06	Accept
Port.07	Accept
Port.08	Accept
G1	Accept
G2	Accept

802.1x Port Authorize State interface

### 5.1.8.5 IP Guard

#### IP Guard – Port Setting

This page allows you to configure port configuration of IP Guard. IP Guard is an intelligent and easy use function for IP security. It could protect the network from unknown IP( the IP not in allowed list) attack. The illegal IP traffic will be blocked.

Port No.	Mode
Port.01	Monitor
Port.02	Security
Port.03	Disabled
Port.04	Disabled

IP Guard – Port Setting State interface

The following table describes the labels in this screen.

Label	Description
<b>Mode</b>	<ul style="list-style-type: none"> <li>■ <b>Disable mode:</b> function is totally disabled.</li> <li>■ <b>Monitor mode:</b> function is disabled, but keeps monitor the IP traffic.</li> <li>■ <b>Security mode:</b> function is enabled, the illegal IP</li> </ul>

	<b>traffic will be blocked.</b>
<b>Apply</b>	Click " <b>Apply</b> " to set the configurations.
<b>Help</b>	Show help file.

### IP Guard – Allow List

IP Guard is an intelligent and easy use function for IP security. It could protect the network from unknown IP( the IP not in allowed list) attack. The illegal IP traffic will be blocked.

This page allows you to configure IP Guard allowed list. The IP traffic will be blocked, if it was not in allowed list

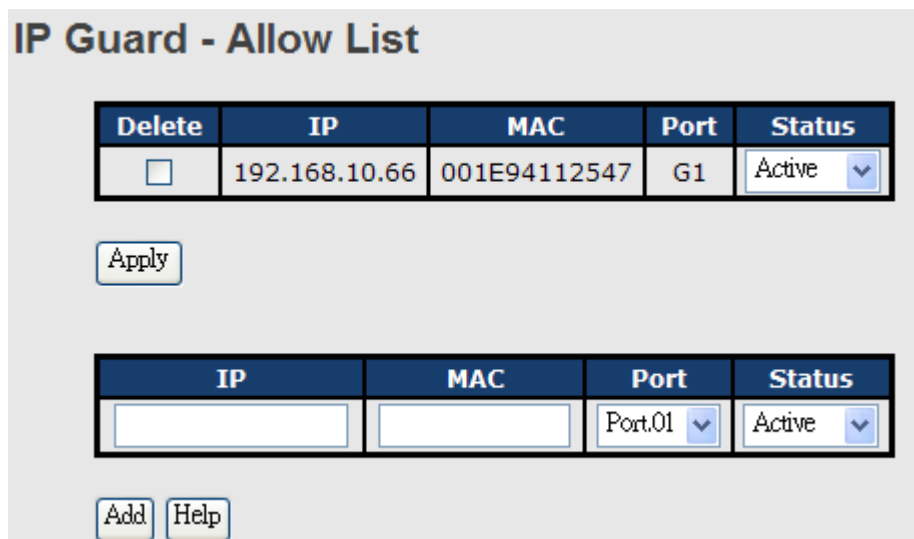

**IP Guard - Allow List**

Delete	IP	MAC	Port	Status
<input type="checkbox"/>	192.168.10.66	001E94112547	G1	Active

Apply

IP	MAC	Port	Status
<input type="text"/>	<input type="text"/>	Port.01	Active

Add Help

IP Guard – Allow List State interface

The following table describes the labels in this screen.

Label	Description
<b>IP</b>	IP address of the allowed entry.
<b>MAC</b>	MAC address of the allowed entry.
<b>Port</b>	Port number of the allowed entry.
<b>Status</b>	If you doubt some allowed IP traffic are abnormal, you could block the traffic use this field. Active: Allow the IP traffic. Suspend: Block the IP traffic.
<b>Delete</b>	If you want to delete the entry, please check this box and apply it.



### IP Guard – Super-IP List

IP Guard is an intelligent and easy use function for IP security. It could protect the network from unknown IP( the IP not in allowed list) attack. The illegal IP traffic will be blocked.

This page allows you to configure IP Guard Super-IP list. Super-IP entry has a special priority, the IP has no limited of MAC address and port binding. Any IP traffic are allowed, when the IP is in the Super-IP list.

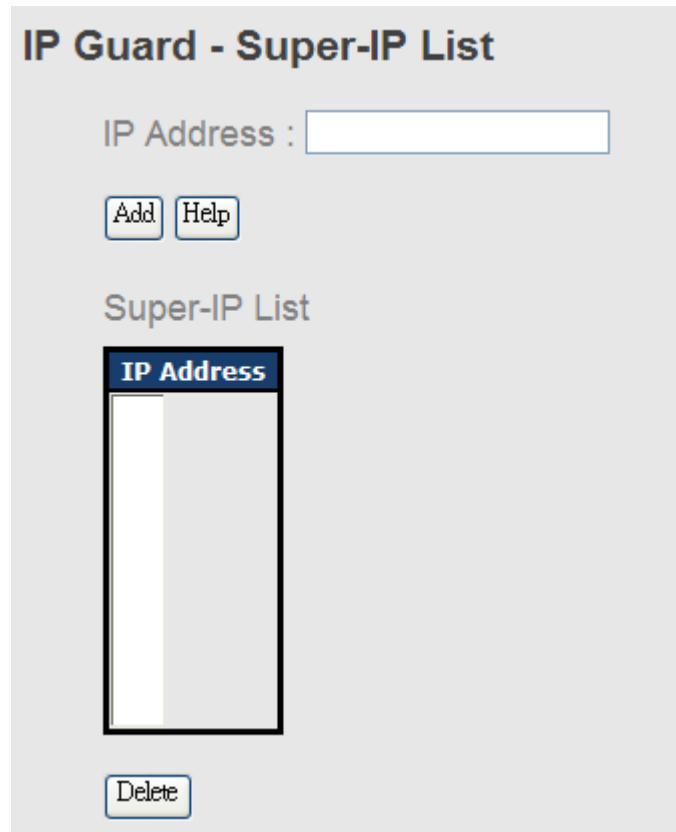

**IP Guard - Super-IP List**

IP Address :

Super-IP List

IP Address

IP Guard – Super-IP List State interface

### IP Guard – Super-IP List

IP Guard is an intelligent and easy use function for IP security. It could protect the network from unknown IP( the IP not in allowed list) attack. The illegal IP traffic will be blocked.

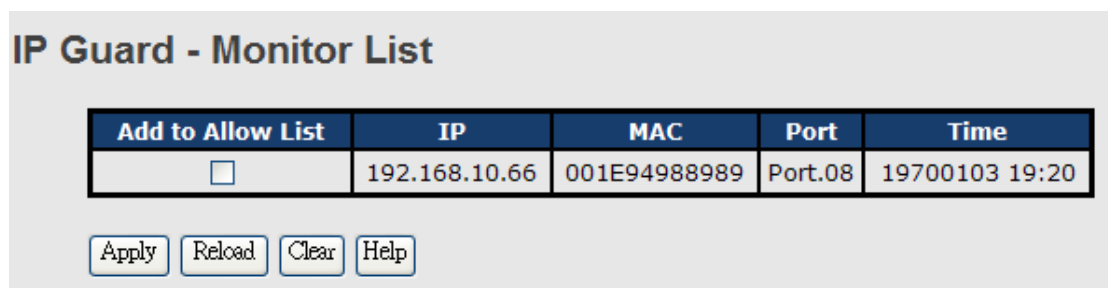

**IP Guard - Monitor List**

Add to Allow List	IP	MAC	Port	Time
<input type="checkbox"/>	192.168.10.66	001E94988989	Port.08	19700103 19:20

The following table describes the labels in this screen.

Label	Description
<b>IP</b>	IP address of entry.
<b>MAC</b>	MAC address of entry.
<b>Port</b>	Port number of entry.
<b>Time</b>	The logged time .
<b>Add to Allow List</b>	If you want to allow the IP traffic, please check this box and apply it.

### 5.1.9 Warning

Warning function is very important for managing switch. You can manage switch by SYSLOG, E-MAIL, and Fault Relay. It helps you to monitor the switch status on remote site. When events occurred, the warning message will send to your appointed server, E-MAIL, or relay fault to switch panel.

System alarm support two warning mode: 1. SYSLOG. 2. E-MAIL. You can monitor switch through selected system events.

#### Warning – Fault Relay Alarm

When any selected fault event is happened, the Fault LED in switch panel will light up and the electric relay will signal at the same time.

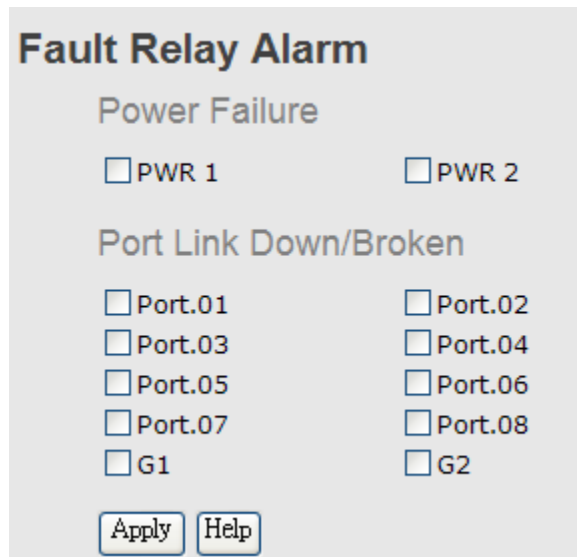

**Fault Relay Alarm**

Power Failure

PWR 1       PWR 2

Port Link Down/Broken

Port.01       Port.02  
 Port.03       Port.04  
 Port.05       Port.06  
 Port.07       Port.08  
 G1             G2

### System Warning – SYSLOG Setting

The SYSLOG is a protocol to transmit event notification messages across networks. Please refer to RFC 3164 - The BSD SYSLOG Protocol

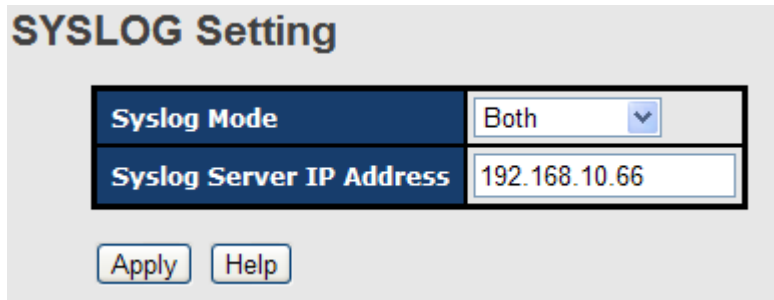

System Warning – SYSLOG Setting interface

The following table describes the labels in this screen.

Label	Description
<b>SYSLOG Mode</b>	<ul style="list-style-type: none"> <li>■ <b>Disable:</b> disable SYSLOG.</li> <li>■ <b>Client Only:</b> log to local system.</li> <li>■ <b>Server Only:</b> log to a remote SYSLOG server.</li> <li>■ <b>Both:</b> log to both of local and remote server.</li> </ul>
<b>SYSLOG Server IP Address</b>	The remote SYSLOG Server IP address.
<b>Apply</b>	Click " <b>Apply</b> " to set the configurations.
<b>Help</b>	Show help file.

### System Warning – SMTP Setting

The SMTP is Short for Simple Mail Transfer Protocol. It is a protocol for e-mail transmission across the Internet. Please refer to RFC 821 - Simple Mail Transfer Protocol.

### SMTP Setting

E-mail Alert:

<b>SMTP Server IP Address :</b>	<input type="text" value="192.168.10.66"/>
<b>Mail Subject :</b>	<input type="text" value="Automated Email Alert"/>
<b>Sender :</b>	<input type="text" value="test mail"/>
<input type="checkbox"/> <b>Authentication</b>	
<b>Rcpt e-mail Address 1 :</b>	<input type="text" value="test@192.168.10.66"/>
<b>Rcpt e-mail Address 2 :</b>	<input type="text"/>
<b>Rcpt e-mail Address 3 :</b>	<input type="text"/>
<b>Rcpt e-mail Address 4 :</b>	<input type="text"/>

System Warning – SMTP Setting interface

The following table describes the labels in this screen.

Label	Description
<b>E-mail Alert</b>	Enable/Disable transmission system warning events by e-mail.
<b>SMTP Server IP Address</b>	Setting up the mail server IP address
<b>Mail Subject</b>	The Subject of the mail
<b>Sender</b>	Set up the email account to send the alert.
<b>Authentication</b>	<ul style="list-style-type: none"> <li>■ <b>Username:</b> the authentication username.</li> <li>■ <b>Password:</b> the authentication password.</li> <li>■ <b>Confirm Password:</b> re-enter password.</li> </ul>
<b>Recipient E-mail Address</b>	The recipient's E-mail address. It supports 6 recipients for a mail.
<b>Apply</b>	Click " <b>Apply</b> " to set the configurations.
<b>Help</b>	Show help file.

### System Warning – Event Selection

SYSLOG and SMTP are the two warning methods that supported by the system. Check the corresponding box to enable system event warning method you wish to choose. Please note that the checkbox can not be checked when SYSLOG or SMTP is disabled.

### Event Selection

#### System Event

Event Type	Syslog	SMTP
Device cold start	<input checked="" type="checkbox"/>	<input type="checkbox"/>
Device warm start	<input checked="" type="checkbox"/>	<input type="checkbox"/>
Authentication failure	<input type="checkbox"/>	<input checked="" type="checkbox"/>
O-Ring topology change	<input type="checkbox"/>	<input checked="" type="checkbox"/>

#### Port Event

Port	Syslog	SMTP
Port.01	Link Down <span style="float: right;">▼</span>	Disable <span style="float: right;">▼</span>
Port.02	Disable <span style="float: right;">▼</span>	Link Up & Link Down <span style="float: right;">▼</span>

System Warning – Event Selection interface

The following table describes the labels in this screen.

Label	Description
<b>Device cold start</b>	When the device executes cold start, the system will issue a log event.
<b>Device warm start</b>	When the device executes warm start, the system will issue a log event.
<b>Authentication Failure</b>	Alert when SNMP authentication failure.
<b>O-Ring topology change</b>	Alert when O-Ring topology changes.
<b>Port Event</b>	<ul style="list-style-type: none"> <li>■ <b>Disable</b></li> <li>■ <b>Link Up</b></li> <li>■ <b>Link Down</b></li> <li>■ <b>Link Up &amp; Link Down</b></li> </ul>
<b>Apply</b>	Click " <b>Apply</b> " to set the configurations.
<b>Help</b>	Show help file.

## 5.1.10 Monitor and Diag

### 5.1.10.1 System Event Log

If system log client is enabled, the system event logs will be shown in this table.

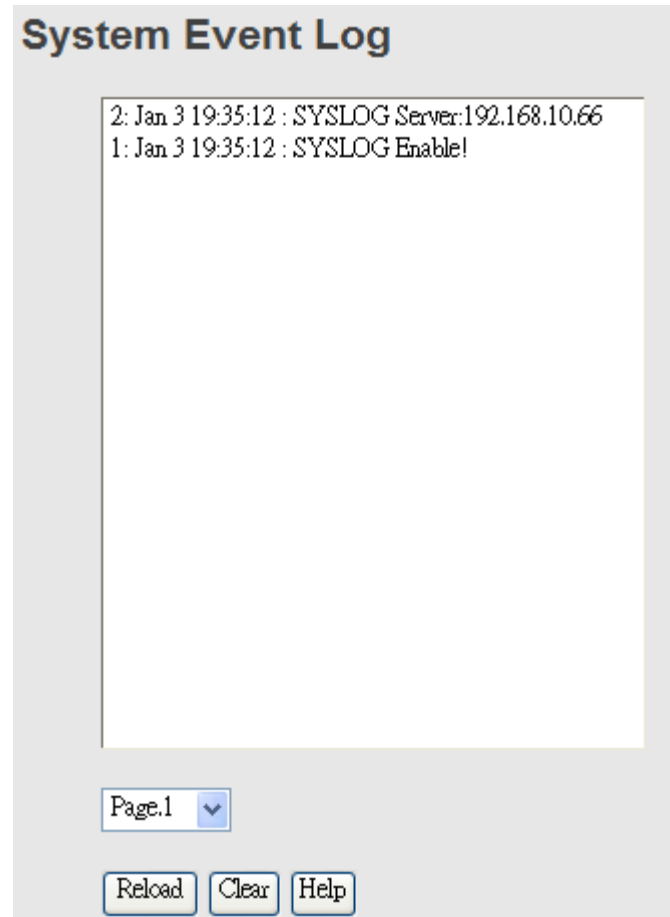

System event log interface

The following table describes the labels in this screen.

Label	Description
<b>Page</b>	Select LOG page.
<b>Reload</b>	To get the newest event logs and refresh this page.
<b>Clear</b>	Clear log.
<b>Help</b>	Show help file.

### 5.1.10.2 MAC Address Table

Refer to IEEE 802.1 D Sections 7.9. The MAC Address Table, that is Filtering Database, supports queries by the Forwarding Process, as to whether a frame received by a given port with a given destination MAC address is to be forwarded through a given potential transmission port.

## MAC Address Table

Port No. :

Type	MAC Address	Port No.
Static	001122334455	Port.06
Dynamic	001E94988989	Port.08
Static	01005E000006	Port.05

Dynamic Address Count : 1  
Static Address Count : 2

### MAC Address Aging Setting

MAC Address Aging Time:

Auto Flush Table When Ports Link Down:

MAC Address Auto Learning:

MAC Address Table interface

The following table describes the labels in this screen.

Label	Description
<b>Port NO. :</b>	Show all MAC addresses mapping to a selected port in table.
<b>Flush MAC Table</b>	Clear all MAC addresses in table
<b>MAC Address Aging Time</b>	Assign aging time MUST be multiple of 15.
<b>Auto Flush Table When Ports Link Down</b>	Enable this function , when port link down , switch will Flush MAC table.
<b>MAC Address Auto Learning</b>	Enable or Disable MAC Learning function .
<b>Apply</b>	Click "Apply" to set the configurations.



### 5.1.10.3 Port Overview

Port statistics show several statistics counters for all ports

#### Port Overview

Port No.	Type	Link	State	TX Good Packet	TX Bad Packet	RX Good Packet	RX Bad Packet	TX Abort Packet	Packet Collision
Port.01	100TX	Down	Forwarding	0	0	0	0	0	0
Port.02	100TX	Down	Forwarding	0	0	0	0	0	0
Port.03	100TX	Down	Forwarding	0	0	0	0	0	0
Port.04	100TX	Down	Forwarding	0	0	0	0	0	0

Port Overview interface

The following table describes the labels in this screen.

Label	Description
<b>Type</b>	Show port speed and media type.
<b>Link</b>	Show port link status.
<b>State</b>	Show ports enable or disable.
<b>TX GOOD Packet</b>	The number of good packets sent by this port.
<b>TX Bad Packet</b>	The number of bad packets sent by this port.
<b>RX GOOD Packet</b>	The number of good packets received by this port.
<b>RX Bad Packet</b>	The number of bad packets received by this port.
<b>TX Abort Packet</b>	The number of packets aborted by this port.
<b>Packet Collision</b>	The number of times a collision detected by this port.
<b>Clear</b>	Clear all counters.
<b>Help</b>	Show help file.



### 5.1.10.4 Port Counters

This page shows statistic counters for the port. The "Clear" button is to reset all counters to zero for all ports.

Port No. :

<b>InGoodOctetsLo</b>	<b>InGoodOctetsHi</b>	<b>InBadOctets</b>	<b>OutFCSErr</b>
0	0	0	0
<b>InUnicasts</b>	<b>Deferred</b>	<b>InBroadcasts</b>	<b>InMulticasts</b>
0	0	0	0
<b>Octets64</b>	<b>Octets127</b>	<b>Octets255</b>	<b>Octets511</b>
0	0	0	0
<b>Octets1023</b>	<b>OctetsMax</b>	<b>OutOctetsLo</b>	<b>OutOctetsHi</b>
0	0	0	0
<b>OutUnicasts</b>	<b>Excessive</b>	<b>OutMulticasts</b>	<b>OutBroadcasts</b>
0	0	0	0
<b>Single</b>	<b>OutPause</b>	<b>InPause</b>	<b>Multiple</b>
0	0	0	0
<b>Undersize</b>	<b>Fragments</b>	<b>Oversize</b>	<b>Jabber</b>
0	0	0	0
<b>InMACRcvErr</b>	<b>InFCSErr</b>	<b>Collisions</b>	<b>Late</b>
0	0	0	0

Port Counters interface

The following table describes the labels in this screen.

Label	Description
<b>InGoodOctetsLo</b>	The lower 32-bits of the 64-bit InGoodOctets counter. The sum of lengths of all good Ethernet frames received, that is frames that are not bad frames.
<b>InGoodOctetsHi</b>	The upper 32-bits of the 64-bit InGoodOctets counter. The sum of lengths of all good Ethernet frames received, that is frames that are not bad frames.
<b>InBadOctets</b>	The sum of lengths of all bad Ethernet frames received.
<b>OutFCSErr</b>	The number of frames transmitted with a invalid FCS. Whenever a frame is modified during transmission(e.g., to add or remove a tag) the frames's original FCS is inspected before a new FCS is added to a modified frame. If the original FCS is invalid, the new FCS is made invalid too and this counter is incremented.
<b>InUnicasts</b>	The number of good frames received that have a Unicast destination MAC address.
<b>Deferred</b>	The total number of successfully transmitted frames that experienced no collisions bu are delayed because the medium was busy during the first attempt. This counter is applicable in



	half-duplex only.
<b>InBroadcasts</b>	The number of good frames received that have a Broadcast destination MAC address.
<b>InMulticasts</b>	The number of good frames received that have a Multicast destination MAC address.
<b>Octets64</b>	Total frames received (and/or transmitted) with a length of exactly 64 octes, include those with errors.
<b>Octets127</b>	Total frames received (and/or transmitted) with a length of between 65 and 127 octes in clusive, including those with error.
<b>Octets255</b>	Total frames received (and/or transmitted) with a length of between 128 and 255 octes in clusive, including those with error.
<b>Octets511</b>	Total frames received (and/or transmitted) with a length of between 256 and 511 octes in clusive, including those with error.
<b>Octets1023</b>	Total frames received (and/or transmitted) with a length of between 512 and 1023 octes in clusive, including those with error.
<b>OctetsMax</b>	Total frames received (and/or transmitted) with a length of between 1024 and MaxSize octes in clusive, including those with error.
<b>OutOctetsLo</b>	The lower 32-bit of the 64-bit OutOctets counter. The sum of lengths of all Ethernet frames sent from this MAC.
<b>OutOctetsHi</b>	The upper 32-bit of the 64-bit OutOctets counter. The sum of lengths of all Ethernet frames sent from this MAC.
<b>OutUnicasts</b>	The number of frames sent that have an Unicast destination MAC address.
<b>Excessive</b>	The number frames dropped in the transmit MAC because the frame experienced 16 consecutive collisions. This counter is applicable in half-duplex only and only of DiscardExcessive is one.
<b>OutBroadcasts</b>	The number of good frames sent that have a Broadcast destination MAC address.
<b>Single</b>	The total number of successfully transmitted frames that experienced exactly one collision. This counter is applicable in half-duplex only.
<b>OutPause</b>	The number of good Flow Control frames sent.
<b>InPause</b>	The number of good Flow Control frames received.
<b>Multiple</b>	The total number of successfully transmitted frames that experienced more than one collision. This counter is applicable in

	half-duplex only.
<b>Undersize</b>	Total frames received with a length of less than 64 octets but with a valid FCS.
<b>Fragments</b>	Total frames received with a length of more than 64 octets and with a invalid FCS.
<b>Oversize</b>	Total frames received with a length of more than MaxSize octets but with a valid FCS.
<b>Jabber</b>	Total frames received with a length of more than MaxSize octets but with an invalid FCS.
<b>InMACRcvErr</b>	Total frames received with an RxErr signal from the PHY.
<b>InFCSErr</b>	Total frames received with a CRC error not counted in Fragments, Jabber or RxErr.
<b>Collisions</b>	The number of collision events seen by MAC not including those conted in Single, Multiple, Excessive or Late. This counter is applicable in half-duplex only.
<b>Late</b>	The number of times a collision is detected later than 512 bits-times into the transmission of a frame. This counter is applicable in half-duplex only.

### 5.1.10.5 Port Monitoring

Port monitoring function supports TX (egress) only, RX (ingress) only, and both TX/RX monitoring. TX monitoring sends any data that egress out checked TX source ports to a selected TX destination port as well. RX monitoring sends any data that ingress in checked RX source ports out to a selected RX destination port as well as sending the frame where it normally would have gone. Note that keep all source ports unchecked in order to disable port monitoring.

**Port Monitoring**

Port No.	Destination Port		Source Port	
	RX	TX	RX	TX
Port.01	<input checked="" type="radio"/>	<input checked="" type="radio"/>	<input type="checkbox"/>	<input type="checkbox"/>
Port.02	<input type="radio"/>	<input type="radio"/>	<input type="checkbox"/>	<input type="checkbox"/>
Port.03	<input type="radio"/>	<input type="radio"/>	<input type="checkbox"/>	<input type="checkbox"/>
Port.04	<input type="radio"/>	<input type="radio"/>	<input type="checkbox"/>	<input type="checkbox"/>

Port monitoring interface

The following table describes the labels in this screen.

Label	Description
<b>Destination Port</b>	The port will receive a copied frame from source port for monitoring purpose.
<b>Source Port</b>	The port will be monitored. Mark the blank of TX or RX to be monitored.
<b>TX</b>	The frames come into switch port.
<b>RX</b>	The frames receive by switch port.
<b>Apply</b>	Click " <b>Apply</b> " to activate the configurations.
<b>Clear</b>	Clear all marked blank.(disable the function)
<b>Help</b>	Show help file.

### 5.1.10.6 Traffic Monitor

The function can monitor switch Traffic. If traffic is too large, Switch will sent SYSLOG Event or SMTP Mail .

**Traffic Monitor**

Port No.	Monitored-Counter	Time-Interval (1~300s)	Increasing-Quantity
Port.01	RX Octet	3	1000
Port.02	RX Broadcast	3	1000
Port.03	RX Multicast	3	1000
Port.04	RX Unicast	3	1000
Port.05	RX Non-Unicast	3	1000
Port.06	Disable	3	1000

System event log interface

The following table describes the labels in this screen.

Label	Description
<b>Monitored –Counter</b>	Select monitor type .
<b>Time-Interval</b>	Setting Interval time .
<b>Increasing – Quantity</b>	Setting alarm Quantity
<b>Event Alarm</b>	Select alarm function (SYSLOG or SMTP)

### 5.1.10.7 SFP Monitor

DDM function, can pass SFP module which supports DDM function, measure the temperature of the apparatus .And manage and set up event alarm module through DDM WEB

### SFP Monitor

Port No.	Temperature (°C)	Vcc (V)	TX Bias (mA)	TX Power (μW)	RX Power (μW)
G1	N/A	N/A	N/A	N/A	N/A
G2	N/A	N/A	N/A	N/A	N/A

Warning Temperature :  °C(0~100)

Event Alarm :  Syslog  SMTP

Label	Description
<b>Warning Temperature</b>	Setting Warning Temperature
<b>Event Alarm</b>	Select warning method(syslog or SMTP)

### 5.1.10.8 Ping

Ping function allows the switch to send ICMP packets to detect the remote notes.

### Ping

IP Address :

### Ping Log

Pinging 192.168.10.66: seq 1 sent...  
Reply seq 1 from 192.168.10.66

Pinging 192.168.10.66: seq 2 sent...  
Reply seq 2 from 192.168.10.66

Pinging 192.168.10.66: seq 3 sent...  
Reply seq 3 from 192.168.10.66

Pinging 192.168.10.66: seq 4 sent...  
Reply seq 4 from 192.168.10.66

Ping complete: sent 4, received 4

Ping interface

The following table describes the labels in this screen.

Label	Description
<b>IP Address</b>	Enter the IP address that you want to detect.
<b>Active</b>	Click "Active" to send ICMP packets

## 5.1.11 Power over Ethernet (P.O.E.)

### 5.1.11.1 System setting

The following interface is the P.O.E. setting interface. There are 8 ports (port 1 to port 8) act as P.S.E. (Power Supply Equipment) ports.

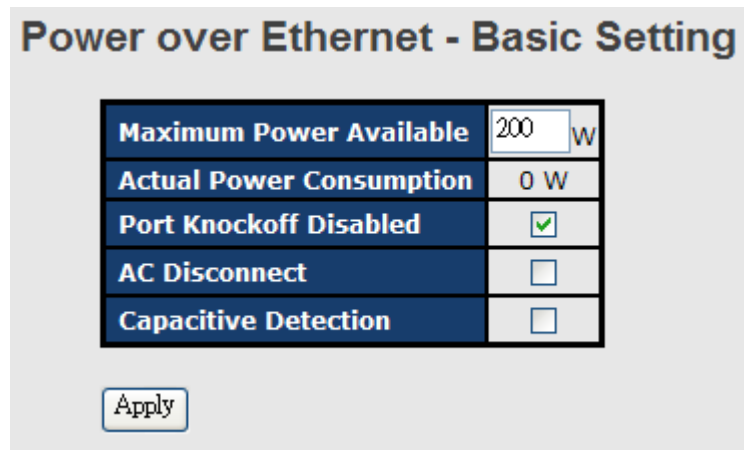

Power over Ethernet - Basic Setting	
<b>Maximum Power Available</b>	200 W
<b>Actual Power Consumption</b>	0 W
<b>Port Knockoff Disabled</b>	<input checked="" type="checkbox"/>
<b>AC Disconnect</b>	<input type="checkbox"/>
<b>Capacitive Detection</b>	<input type="checkbox"/>

Apply

Label	Description
<b>Maximum Power Available</b>	Display the maximum power available.
<b>Actual Power Consumption</b>	Display the actual power consumption.
<b>Pork Knockoff Disabled</b>	Mark the blank to enable "Pork Knock off Disabled" function.
<b>AC Disconnect</b>	Mark the blank to enable "AC Disconnect" function.
<b>Capacitive Detection</b>	Mark the blank to enable "Capacitive Detection" function

### 5.1.11.2 Power over Ethernet - Port Control

The following interface is the P.O.E. setting interface. There are 8 ports (port 1 to port 8) act as P.S.E. (Power Supply Equipment) ports.

### Power over Ethernet - Port Setting

Port No.	Enable	Power Limit From Classification	Legacy	Priority	Power Limit (<15400)(mW)
Port.01	<input checked="" type="checkbox"/>	<input type="checkbox"/>	<input type="checkbox"/>	Low <span style="font-size: small;">▼</span>	15400
Port.02	<input checked="" type="checkbox"/>	<input type="checkbox"/>	<input type="checkbox"/>	Low <span style="font-size: small;">▼</span>	15400
Port.03	<input checked="" type="checkbox"/>	<input type="checkbox"/>	<input type="checkbox"/>	Low <span style="font-size: small;">▼</span>	15400
Port.04	<input checked="" type="checkbox"/>	<input type="checkbox"/>	<input type="checkbox"/>	Low <span style="font-size: small;">▼</span>	15400
Port.05	<input checked="" type="checkbox"/>	<input type="checkbox"/>	<input type="checkbox"/>	Low <span style="font-size: small;">▼</span>	15400
Port.06	<input checked="" type="checkbox"/>	<input type="checkbox"/>	<input type="checkbox"/>	Low <span style="font-size: small;">▼</span>	15400
Port.07	<input checked="" type="checkbox"/>	<input type="checkbox"/>	<input type="checkbox"/>	Low <span style="font-size: small;">▼</span>	15400
Port.08	<input checked="" type="checkbox"/>	<input type="checkbox"/>	<input type="checkbox"/>	Low <span style="font-size: small;">▼</span>	15400

Label	Description
<b>Port</b>	Port number.
<b>Enable state</b>	Mark the blank to enable P.O.E. function for specific ports
<b>Power Limit From Classification</b>	Set the “ <b>Power Limit From Classification</b> ” function for each P.O.E. ports
<b>Legacy</b>	The legacy detection is to identify the PD devices that did not follow the IEEE 802.3af standard their unique electrical signatures in order for the P.O.E. switch can provide the power to those PD devices
<b>Priority</b>	Set port priority for the P.O.E. power management. 1 = C (critical), 2 = H (High), 3 = L (Low)
<b>Power Limit</b>	Set the power limit value. The maximum value must less 15400

### 5.1.11.3 Port Status

Show P.O.E. each Port, the situation in detail.

**Power over Ethernet - Port Status**

Port No.	State	Current (mA)	Voltage (V)	Power (mW)	Class
Port.01	Detecting	--	--	--	--
Port.02	Detecting	--	--	--	--
Port.03	Detecting	--	--	--	--
Port.04	Detecting	--	--	--	--
Port.05	Detecting	--	--	--	--
Port.06	Detecting	--	--	--	--
Port.07	Detecting	--	--	--	--
Port.08	Not PD	--	--	--	--

Label	Description
<b>Port</b>	Port number.
<b>Link</b>	P.S.E. Function Port Link or Down
<b>State</b>	Show P.S.E. Status.
<b>Power Limit From Classification</b>	Set the " <b>Power Limit From Classification</b> " function for each P.O.E. ports
<b>Current(mA)</b>	Display current value
<b>Voltage(V)</b>	Display voltage value
<b>Power(mW)</b>	Display watt value
<b>Determined Class</b>	Display power class. When the Bypass classification enable, the class value will not show in here

### 5.1.11.4 Power over Ethernet – Boot Delay

Start Delay enable feature, users can define their own time for P.O.E. power supply.

**Power over Ethernet - Boot Delay**

Port No.	Delay Mode	Delay Time(0~300)
Port.01	Disable <input type="button" value="v"/>	<input type="text" value="0"/> Second(s)
Port.02	Disable <input type="button" value="v"/>	<input type="text" value="0"/> Second(s)
Port.03	Disable <input type="button" value="v"/>	<input type="text" value="0"/> Second(s)



Label	Description
<b>Port</b>	Port number.
<b>Delay Mode</b>	Enable or disable Delay Mode
<b>Delay Time(0-300)</b>	Time to provide power

### 5.1.11.5 Ping Alive Check

You can control the P.O.E. function by using the ping command , in order to turn on or off other P.O.E. device which connect with port assign.

#### Power over Ethernet - Ping Alive Check

Mode : Enabled ▼

Port No.	IP Address of PD	Interval Time (10~120) seconds	Retry Time (1~5)	Failure Log	Failure Action	Reboot Time (3~120) seconds
Port.01	<input type="text" value="0.0.0.0"/>	<input type="text" value="30"/>	<input type="text" value="3"/>	error=0 total=0	<span style="border: 1px solid #ccc; padding: 2px;">Nothing</span> ▼	<input type="text" value="15"/>
Port.02	<input type="text" value="0.0.0.0"/>	<input type="text" value="30"/>	<input type="text" value="3"/>	error=0 total=0	<span style="border: 1px solid #ccc; padding: 2px;">Nothing</span> ▼	<input type="text" value="15"/>
Port.03	<input type="text" value="0.0.0.0"/>	<input type="text" value="30"/>	<input type="text" value="3"/>	error=0 total=0	<span style="border: 1px solid #ccc; padding: 2px;">Nothing</span> ▼	<input type="text" value="15"/>
Port.04	<input type="text" value="0.0.0.0"/>	<input type="text" value="30"/>	<input type="text" value="3"/>	error=0 total=0	<span style="border: 1px solid #ccc; padding: 2px;">Nothing</span> ▼	<input type="text" value="15"/>
Port.05	<input type="text" value="0.0.0.0"/>	<input type="text" value="30"/>	<input type="text" value="3"/>	error=0 total=0	<span style="border: 1px solid #ccc; padding: 2px;">Nothing</span> ▼	<input type="text" value="15"/>
Port.06	<input type="text" value="0.0.0.0"/>	<input type="text" value="30"/>	<input type="text" value="3"/>	error=0 total=0	<span style="border: 1px solid #ccc; padding: 2px;">Nothing</span> ▼	<input type="text" value="15"/>
Port.07	<input type="text" value="0.0.0.0"/>	<input type="text" value="30"/>	<input type="text" value="3"/>	error=0 total=0	<span style="border: 1px solid #ccc; padding: 2px;">Nothing</span> ▼	<input type="text" value="15"/>
Port.08	<input type="text" value="0.0.0.0"/>	<input type="text" value="30"/>	<input type="text" value="3"/>	error=0 total=0	<span style="border: 1px solid #ccc; padding: 2px;">Nothing</span> ▼	<input type="text" value="15"/>

Event Alarm by SMTP : Disable ▼

Apply Refresh

The following table describes the labels in this screen.

Label	Description
<b>Ping Check</b>	Enable or disable Ping Check function
<b>Send Mail</b>	When " ping " fails, can notify users by mail
<b>Port</b>	You can appoint to want to control P.O.E. port number
<b>Ping IP Address</b>	Set up IP Address
<b>Interval Time</b>	Spacing interval to set up Ping(10 sec~120 sec)
<b>Retry Time</b>	Set up the number of times of ping
<b>Failure Log</b>	Note down " Ping Check " a result of movement after starting.

<b>Failure Action</b>	Set up movements wanted to carry out
<b>Reboot Time</b>	Switch ping check failure " P.O.E. " restarts the buffer time of switch.
<b>Event Alarm by SMTP</b>	Sent alarm message form SMTP mail .

### 5.1.11.6 Schedule

User can appointed date and time, Enable or Close Power Over Ethernet Function, switch can with according to the time when is set up, carry on the designated movements (SNTP Function must Enable)

## Power over Ethernet - Scheduling

Port No :  ▼

Mode :  ▼

Select all

Hour	Sunday	Monday	Tuesday	Wednesday	Thursday	Friday	Saturday
00 ✓	✓	✓	✓	✓	✓	✓	✓
01 ✓	✓	✓	✓	✓	✓	✓	✓
02 ✓	✓	✓	✓	✓	✓	✓	✓
03 ✓	✓	✓	✓	✓	✓	✓	✓
04 ✓	✓	✓	✓	✓	✓	✓	✓
05 ✓	✓	✓	✓	✓	✓	✓	✓
06 ✓	✓	✓	✓	✓	✓	✓	✓
07 ✓	✓	✓	✓	✓	✓	✓	✓

The following table describes the labels in this screen.

Label	Description
<b>Schedule on</b>	Setting action port
<b>Schedule mode</b>	Schedule mode enable or disable
<b>Select all</b>	Select all Data & Time
<b>Hour</b>	Set up enable Time
<b>Sunday ~ Saturday</b>	Set up enable Data

### 5.1.12 Save Configuration

If any configuration changed, “**Save Configuration**” should be clicked to save current configuration data to the permanent flash memory. Otherwise, the current configuration will be lost when power off or system reset.



System Configuration interface

The following table describes the labels in this screen.

Label	Description
<b>Save</b>	Save all configurations.
<b>Help</b>	Show help file.

### 5.1.13 Factory Default

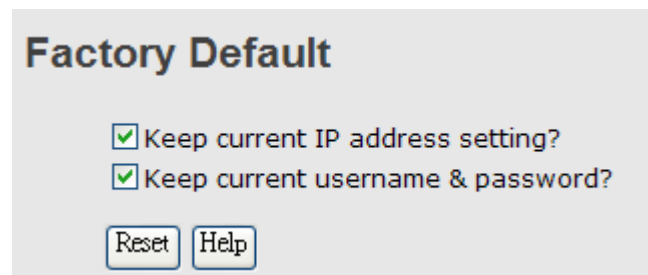

Factory Default interface

Reset switch to default configuration. Click **Reset** to reset all configurations to the default value. You can select “**Keep current IP address setting**” and “**Keep current username & password**” to keep current IP and username and password.

### 5.1.14 System Reboot

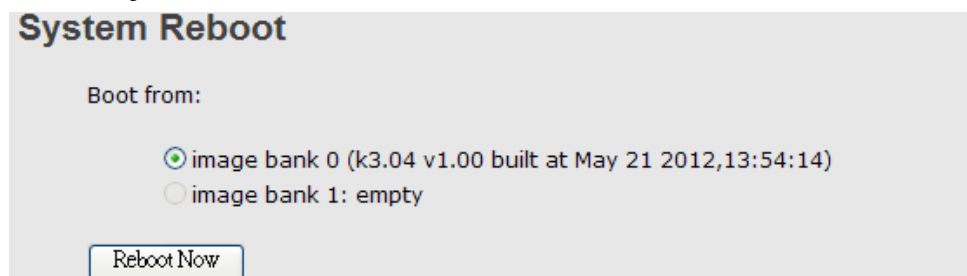

System Reboot interface

# Command Line Interface Management

## 6.1 About CLI Management

Besides WEB-base management, IPS-3082GC / IPS-3082GC-24V also supports CLI management. You can use console or telnet to management switch by CLI.

### CLI Management by RS-232 Serial Console (9600, 8, none, 1, none)

Before Configuring by RS-232 serial console, use an RJ45 to DB9-F cable to connect the Switches' RS-232 Console port to your PCs' COM port.

Follow the steps below to access the console via RS-232 serial cable.

Step 1. From the Windows desktop, click on Start -> Programs -> Accessories -> Communications -> Hyper Terminal

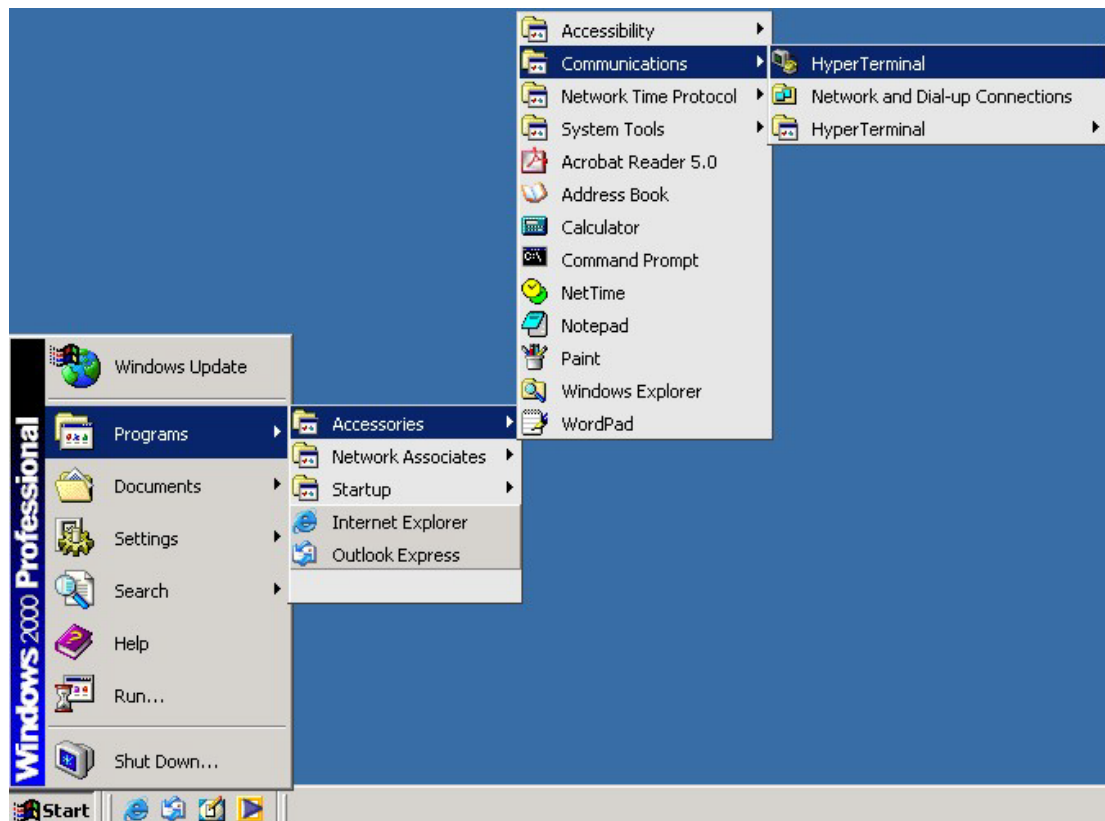

### Step 2. Input a name for new connection

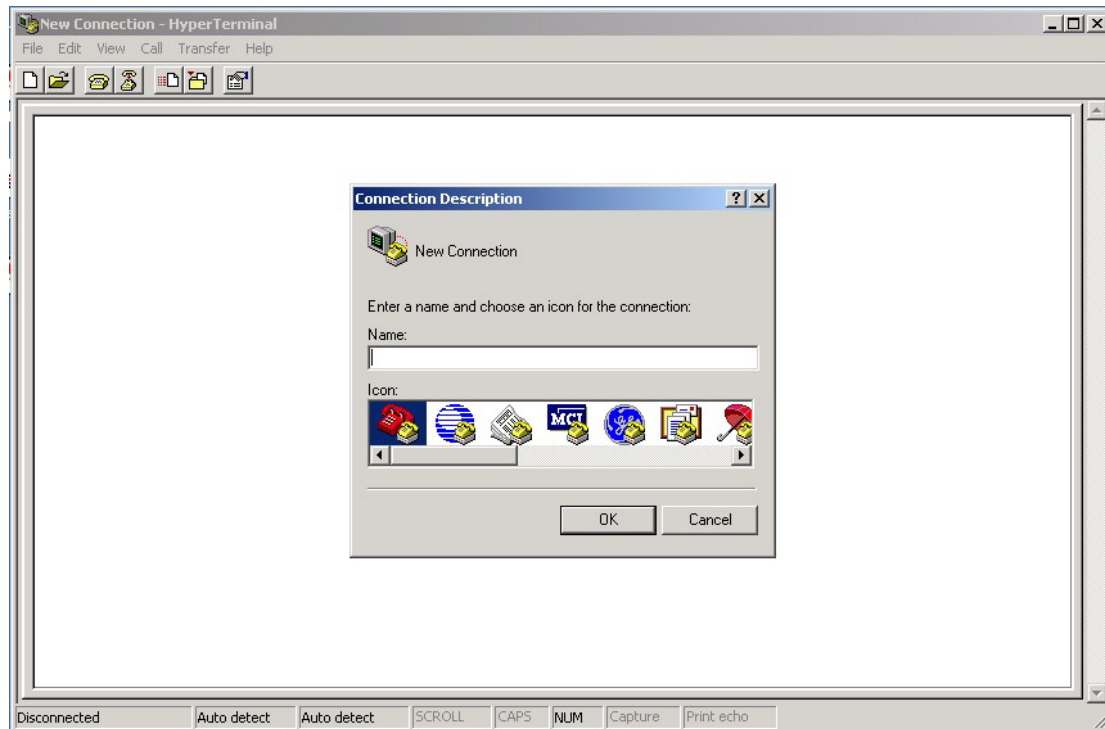

### Step 3. Select to use COM port number

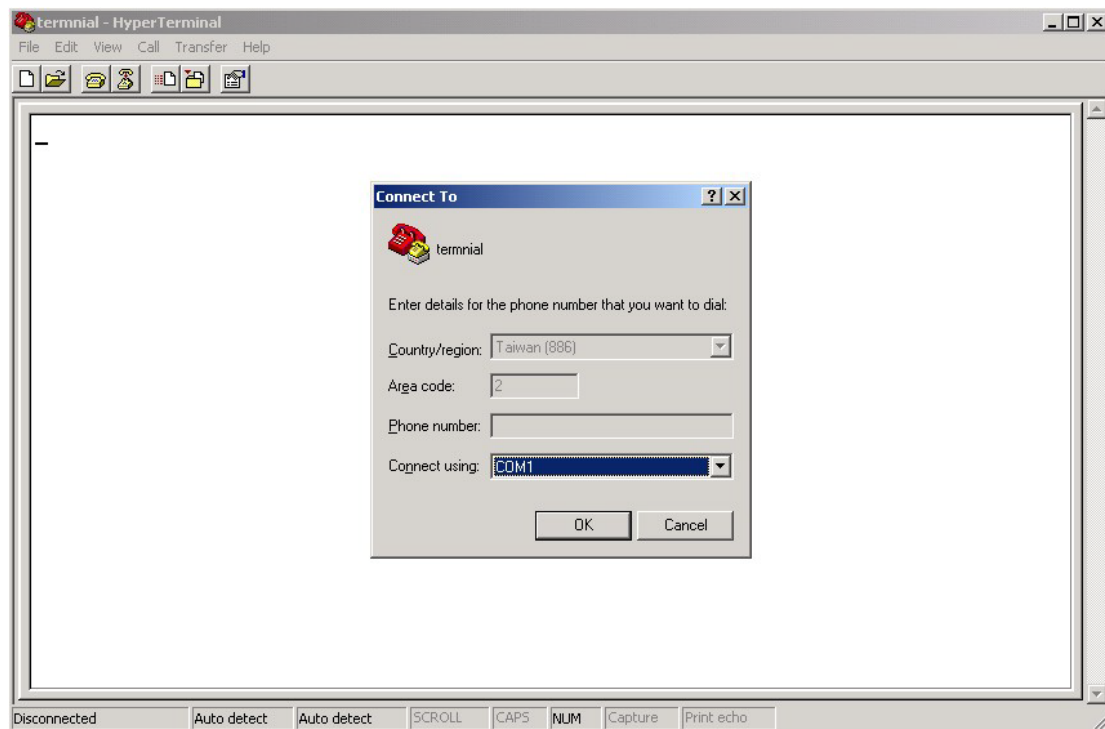

Step 4. The COM port properties setting, 9600 for Bits per second, 8 for Data bits, None for Parity, 1 for Stop bits and none for Flow control.

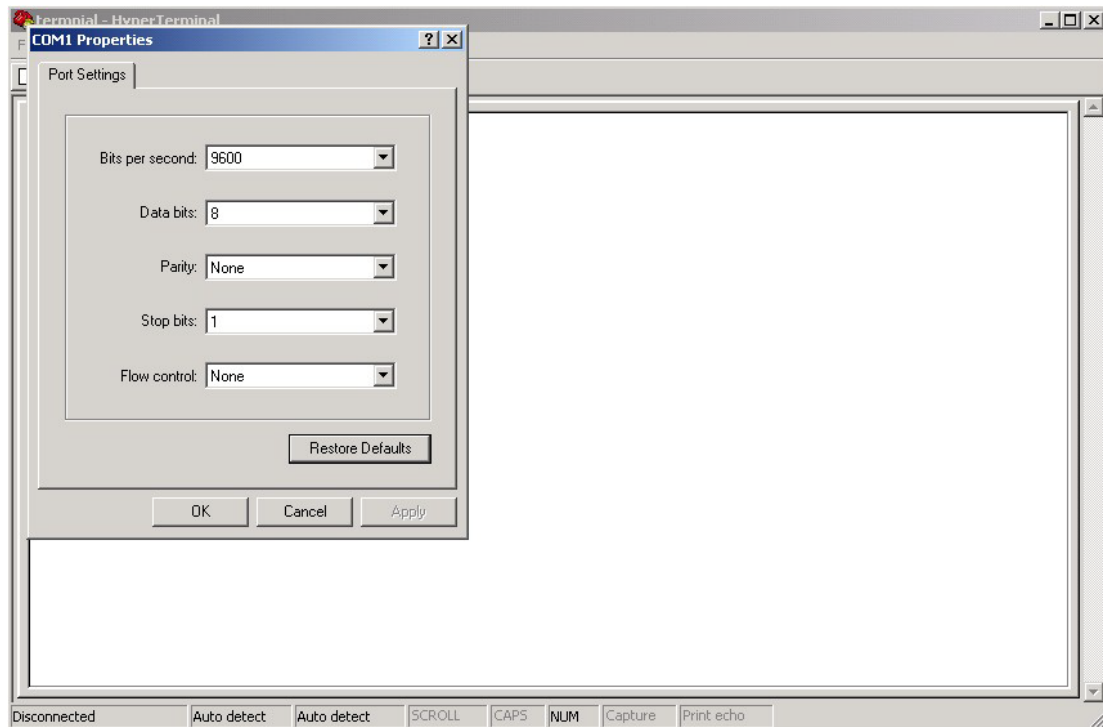

Step 5. The Console login screen will appear. Use the keyboard to enter the Username and Password (The same with the password for Web Browser), then press “Enter”.

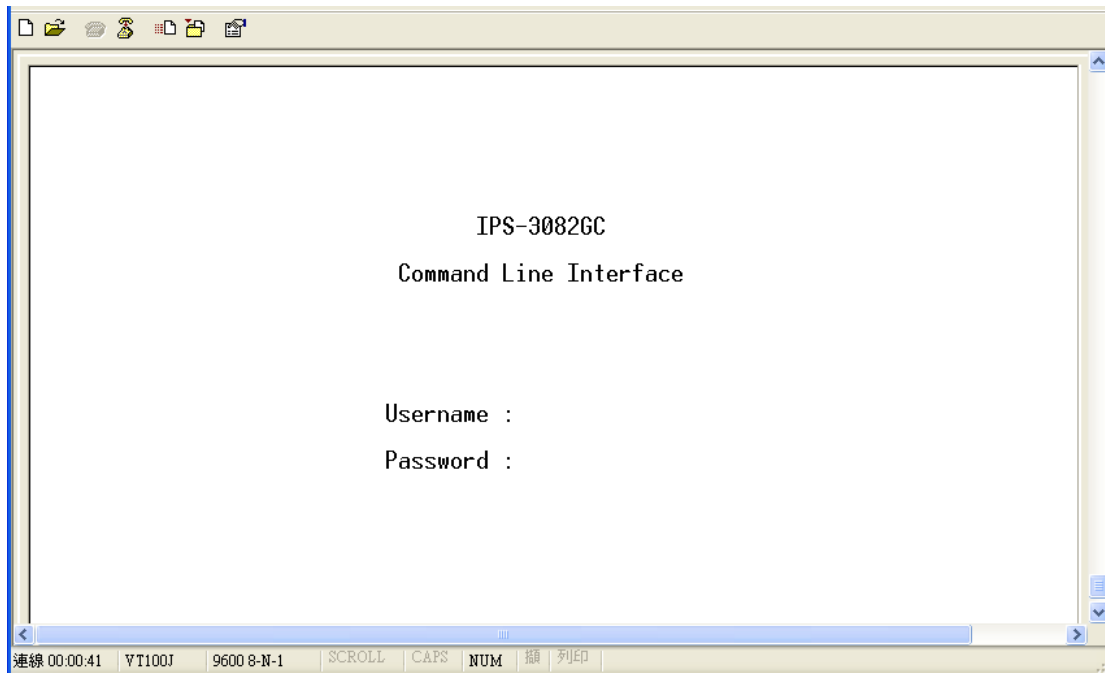

### CLI Management by Telnet

Users can use “TELNET” to configure the switches.

The default value is as below:

IP Address: **192.168.10.1**

Subnet Mask: **255.255.255.0**

Default Gateway: **192.168.10.254**

User Name: **admin**

Password: **admin**

Follow the steps below to access the console via Telnet.

Step 1. Telnet to the IP address of the switch from the Windows **“Run”** command (or from the MS-DOS prompt) as below.

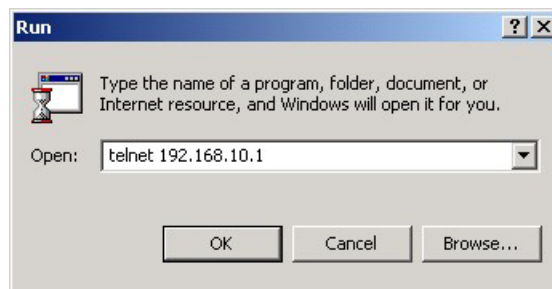

Step 2. The Login screen will appear. Use the keyboard to enter the Username and Password (The same with the password for Web Browser ), and then press **“Enter”**

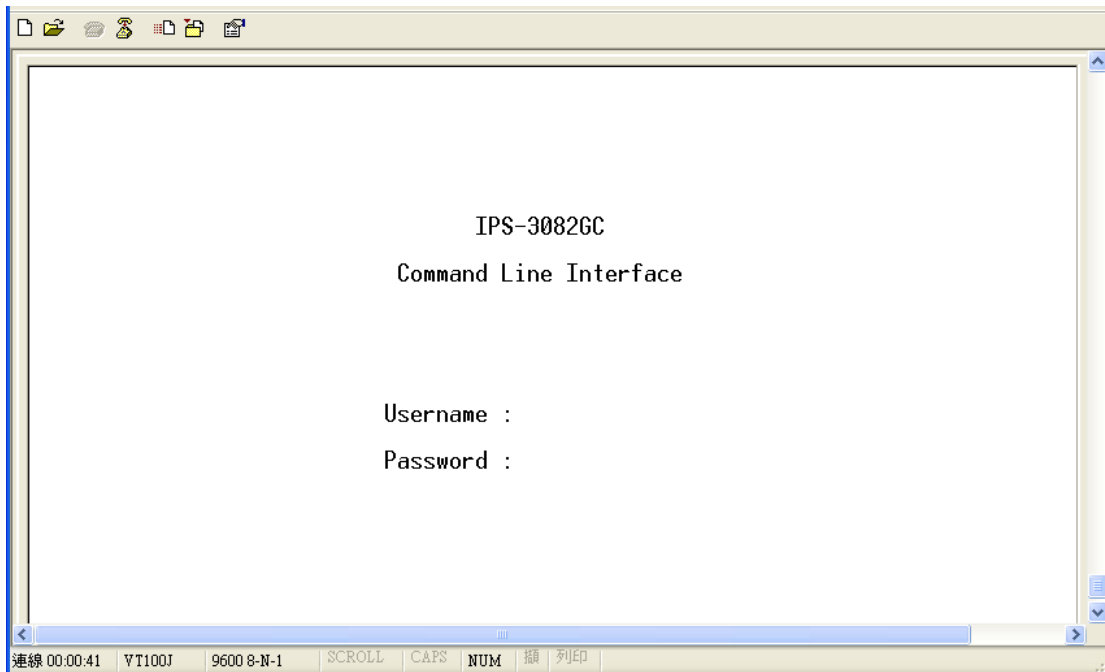



**Commands Level**

<b>Modes</b>	<b>Access Method</b>	<b>Prompt</b>	<b>Exit Method</b>	<b>About This Model</b>
User EXEC	Begin a session with your switch.	switch>	Enter <b>logout</b> or <b>quit</b> .	The user command available at the level of user is the subset of those available at the privileged level. Use this mode to <ul style="list-style-type: none"> <li>• Enter menu mode.</li> <li>• Display system information.</li> </ul>
Privileged EXEC	Enter the <b>enable</b> command while in user EXEC mode.	switch#	Enter <b>disable</b> to exit.	The privileged command is advance mode Privileged this mode to <ul style="list-style-type: none"> <li>• Display advance function status</li> <li>• save configures</li> </ul>
Global configuration	Enter the <b>configure</b> command while in privileged EXEC mode.	switch(co nfig)#	To exit to privileged EXEC mode, enter <b>exit</b> or <b>end</b>	Use this mode to configure parameters that apply to your Switch as a whole.
VLAN database	Enter the <b>vlan database</b> command while in privileged EXEC mode.	switch(vlan)#	To exit to user EXEC mode, enter <b>exit</b> .	Use this mode to configure VLAN-specific parameters.
Interface configuration	Enter the <b>interface</b> command (with a specific interface)while in global configuration mode	switch(co nfig-if)#	To exit to global configuration mode, enter <b>exit</b> . To exist privileged EXEC mode or <b>end</b> .	Use this mode to configure parameters for the switch and Ethernet ports.



**Symbol of Command Level.**

Mode	Symbol of Command Level
User EXEC	E
Privileged EXEC	P
Global configuration	G
VLAN database	V
Interface configuration	I

**6.2 Commands Set List—System Commands Set**

IPS-3082GC / IPS-3082GC-24V Commands	Level	Description	Example
<b>show config</b>	<b>E</b>	Show switch configuration	switch>show config
<b>show terminal</b>	<b>P</b>	Show console information	switch#show terminal
<b>write memory</b>	<b>P</b>	Save your configuration into permanent memory (flash rom)	switch#write memory
<b>system name</b> [System Name]	<b>G</b>	Configure system name	switch(config)#system name xxx
<b>system location</b> [System Location]	<b>G</b>	Set switch system location string	switch(config)#system location xxx
<b>system description</b> [System Description]	<b>G</b>	Set switch system description string	switch(config)#system description xxx
<b>system contact</b> [System Contact]	<b>G</b>	Set switch system contact window string	switch(config)#system contact xxx
<b>show system-info</b>	<b>E</b>	Show system information	switch>show system-info
<b>ip address</b> [Ip-address] [Subnet-mask] [Gateway]	<b>G</b>	Configure the IP address of switch	switch(config)#ip address 192.168.1.1 255.255.255.0 192.168.1.254
<b>ip dhcp</b>	<b>G</b>	Enable DHCP client	switch(config)#ip dhcp



		function of switch	
<b>show ip</b>	<b>P</b>	Show IP information of switch	switch#show ip
<b>no ip dhcp</b>	<b>G</b>	Disable DHCP client function of switch	switch(config)#no ip dhcp
<b>reload</b>	<b>G</b>	Halt and perform a cold restart	switch(config)#reload
<b>default</b>	<b>G</b>	Restore to default	Switch(config)#default
<b>admin username</b> [Username]	<b>G</b>	Changes a login username. (maximum 10 words)	switch(config)#admin username xxxxxx
<b>admin password</b> [Password]	<b>G</b>	Specifies a password (maximum 10 words)	switch(config)#admin password xxxxxx
<b>show admin</b>	<b>P</b>	Show administrator information	switch#show admin
<b>dhcpserver enable</b>	<b>G</b>	Enable DHCP Server	switch(config)#dhcpserver enable
<b>dhcpserver lowip</b> [Low IP]	<b>G</b>	Configure low IP address for IP pool	switch(config)# dhcpserver lowip 192.168.1.1
<b>dhcpserver highip</b> [High IP]	<b>G</b>	Configure high IP address for IP pool	switch(config)# dhcpserver highip 192.168.1.50
<b>dhcpserver subnetmask</b> [Subnet mask]	<b>G</b>	Configure subnet mask for DHCP clients	switch(config)#dhcpserver subnetmask 255.255.255.0
<b>dhcpserver gateway</b> [Gateway]	<b>G</b>	Configure gateway for DHCP clients	switch(config)#dhcpserver gateway 192.168.1.254
<b>dhcpserver dnsip</b> [DNS IP]	<b>G</b>	Configure DNS IP for DHCP clients	switch(config)# dhcpserver dnsip 192.168.1.1
<b>dhcpserver leasetime</b> [Hours]	<b>G</b>	Configure lease time (in hour)	switch(config)#dhcpserver leasetime 1
<b>dhcpserver ipbinding</b> [IP address]	<b>I</b>	Set static IP for DHCP clients by port	switch(config)#interface fastEthernet 2 switch(config-if)#dhcpserver ipbinding 192.168.1.1
<b>show dhcpserver configuration</b>	<b>P</b>	Show configuration of DHCP server	switch#show dhcpserver configuration
<b>show dhcpserver clients</b>	<b>P</b>	Show client entries of DHCP server	switch#show dhcpserver clinets
<b>show dhcpserver</b>	<b>P</b>	Show IP-Binding	switch#show dhcpserver ip-binding



<b>ip-binding</b>		information of DHCP server	
<b>no dhcpserver</b>	<b>G</b>	Disable DHCP server function	switch(config)#no dhcpserver
<b>security enable</b>	<b>G</b>	Enable IP security function	switch(config)#security enable
<b>security http</b>	<b>G</b>	Enable IP security of HTTP server	switch(config)#security http
<b>security telnet</b>	<b>G</b>	Enable IP security of telnet server	switch(config)#security telnet
<b>security ip [Index(1..10)] [IP Address]</b>	<b>G</b>	Set the IP security list	switch(config)#security ip 1 192.168.1.55
<b>show security</b>	<b>P</b>	Show the information of IP security	switch#show security
<b>no security</b>	<b>G</b>	Disable IP security function	switch(config)#no security
<b>no security http</b>	<b>G</b>	Disable IP security of HTTP server	switch(config)#no security http
<b>no security telnet</b>	<b>G</b>	Disable IP security of telnet server	switch(config)#no security telnet

### 6.3 Commands Set List—Port Commands Set

IPS-3082GC / IPS-3082GC-24V Commands	Level	Description	Example
<b>interface fastEthernet [Portid]</b>	<b>G</b>	Choose the port for modification.	switch(config)#interface fastEthernet 2
<b>duplex [full   half]</b>	<b>I</b>	Use the duplex configuration command to specify the duplex mode of operation for Fast Ethernet.	switch(config)#interface fastEthernet 2 switch(config-if)#duplex full



<b>speed</b> [10 100 1000 auto]	I	Use the speed configuration command to specify the speed mode of operation for Fast Ethernet., the speed can't be set to 1000 if the port isn't a giga port..	switch(config)#interface fastEthernet 2 switch(config-if)#speed 100
<b>flowcontrol mode</b> [Symmetric Asymmetric]	I	Use the flowcontrol configuration command on Ethernet ports to control traffic rates during congestion.	switch(config)#interface fastEthernet 2 switch(config-if)#flowcontrol mode Asymmetric
<b>no flowcontrol</b>	I	Disable flow control of interface	switch(config-if)#no flowcontrol
<b>security enable</b>	I	Enable security of interface	switch(config)#interface fastEthernet 2 switch(config-if)#security enable
<b>no security</b>	I	Disable security of interface	switch(config)#interface fastEthernet 2 switch(config-if)#no security
<b>bandwidth type all</b>	I	Set interface ingress limit frame type to "accept all frame"	switch(config)#interface fastEthernet 2 switch(config-if)#bandwidth type all
<b>bandwidth type broadcast-multicast-flooded-unicast</b>	I	Set interface ingress limit frame type to "accept broadcast, multicast, and flooded unicast frame"	switch(config)#interface fastEthernet 2 switch(config-if)#bandwidth type broadcast-multicast-flooded-unicast
<b>bandwidth type broadcast-multicast</b>	I	Set interface ingress limit frame type to "accept broadcast and multicast frame"	switch(config)#interface fastEthernet 2 switch(config-if)#bandwidth type broadcast-multicast
<b>bandwidth type broadcast-only</b>	I	Set interface ingress limit frame type to	switch(config)#interface fastEthernet 2



		“only accept broadcast frame”	switch(config-if)#bandwidth type broadcast-only
<b>bandwidth in</b> [Value]	I	Set interface input bandwidth. Rate Range is from 100 kbps to 102400 kbps or to 256000 kbps for giga ports, and zero means no limit.	switch(config)#interface fastEthernet 2 switch(config-if)#bandwidth in 100
<b>bandwidth out</b> [Value]	I	Set interface output bandwidth. Rate Range is from 100 kbps to 102400 kbps or to 256000 kbps for giga ports, and zero means no limit.	switch(config)#interface fastEthernet 2 switch(config-if)#bandwidth out 100
<b>show bandwidth</b>	I	Show interfaces bandwidth control	switch(config)#interface fastEthernet 2 switch(config-if)#show bandwidth
<b>state</b> [Enable   Disable]	I	Use the state interface configuration command to specify the state mode of operation for Ethernet ports. Use the disable form of this command to disable the port.	switch(config)#interface fastEthernet 2 switch(config-if)#state Disable
<b>show interface configuration</b>	I	show interface configuration status	switch(config)#interface fastEthernet 2 switch(config-if)#show interface configuration
<b>show interface status</b>	I	show interface actual status	switch(config)#interface fastEthernet 2



			switch(config-if)#show interface status
<b>show interface accounting</b>	<b>I</b>	show interface statistic counter	switch(config)#interface fastEthernet 2 switch(config-if)#show interface accounting
<b>no accounting</b>	<b>I</b>	Clear interface accounting information	switch(config)#interface fastEthernet 2 switch(config-if)#no accounting

### 6.4 Commands Set List—Trunk command set

IPS-3082GC / IPS-3082GC-24V Commands	Level	Description	Example
<b>aggregator priority</b> [1to65535]	<b>G</b>	Set port group system priority	switch(config)#aggregator priority 22
<b>aggregator activityport</b> [Port Numbers]	<b>G</b>	Set activity port	switch(config)#aggregator activityport 2
<b>aggregator group</b> [GroupID] [Port-list] <b>lacp</b> <b>workp</b> [Workport]	<b>G</b>	Assign a trunk group with LACP active. [GroupID] :1to3 [Port-list]:Member port list, This parameter could be a port range(ex.1-4) or a port list separate by a comma(ex.2, 3, 6) [Workport]: The amount of work ports, this value could not be less than zero or be large than the amount of member ports.	switch(config)#aggregator group 1 1-4 lacp workp 2 or switch(config)#aggregator group 2 1,4,3 lacp workp 3
<b>aggregator group</b> [GroupID] [Port-list] <b>nolacp</b>	<b>G</b>	Assign a static trunk group. [GroupID] :1to3	switch(config)#aggregator group 1 2-4 nolacp or



		[Port-list]:Member port list, This parameter could be a port range(ex.1-4) or a port list separate by a comma(ex.2, 3, 6)	switch(config)#aggregator group 1 3,1,2 nolacp
<b>show aggregator</b>	<b>P</b>	Show the information of trunk group	switch#show aggregator
<b>no aggregator lacp</b> [GroupID]	<b>G</b>	Disable the LACP function of trunk group	switch(config)#no aggregator lacp 1
<b>no aggregator group</b> [GroupID]	<b>G</b>	Remove a trunk group	switch(config)#no aggregator group 2

## 6.5 Commands Set List—VLAN command set

IPS-3082GC / IPS-3082GC-24V Commands	Level	Description	Example
<b>vlan database</b>	<b>P</b>	Enter VLAN configure mode	switch#vlan database
<b>vlan</b> [8021q   gvrp]	<b>V</b>	To set switch VLAN mode.	switch(vlan)# vlanmode 802.1q or switch(vlan)# vlanmode gvrp
<b>no vlan</b> [VID]	<b>V</b>	Disable vlan group(by VID)	switch(vlan)#no vlan 2
<b>no gvrp</b>	<b>V</b>	Disable GVRP	switch(vlan)#no gvrp
<b>IEEE 802.1Q VLAN</b>			
<b>vlan 8021q port</b> [PortNumber] <b>access-link untag</b> [UntaggedVID]	<b>V</b>	Assign a access link for VLAN by port, if the port belong to a trunk group, this command can't be applied.	switch(vlan)#vlan 802.1q port 3 access-link untag 33
<b>vlan 8021q port</b> [PortNumber] <b>trunk-link tag</b> [TaggedVID List]	<b>V</b>	Assign a trunk link for VLAN by port, if the port belong to a trunk group, this command can't be applied.	switch(vlan)#vlan 8021q port 3 trunk-link tag 2,3,6,99 or switch(vlan)#vlan 8021q port 3 trunk-link tag 3-20



<b>vlan 8021q port</b> [PortNumber] <b>hybrid-link untag</b> [UntaggedVID] <b>tag</b> [TaggedVID List]	V	Assign a hybrid link for VLAN by port, if the port belong to a trunk group, this command can't be applied.	switch(vlan)# vlan 8021q port 3 hybrid-link untag 4 tag 3,6,8 or switch(vlan)# vlan 8021q port 3 hybrid-link untag 5 tag 6-8
<b>vlan 8021q aggregator</b> [TrunkID] <b>access-link untag</b> [UntaggedVID]	V	Assign a access link for VLAN by trunk group	switch(vlan)#vlan 8021q aggregator 3 access-link untag 33
<b>vlan 8021q aggregator</b> [TrunkID] <b>trunk-link tag</b> [TaggedVID List]	V	Assign a trunk link for VLAN by trunk group	switch(vlan)#vlan 8021q aggregator 3 trunk-link tag 2,3,6,99 or switch(vlan)#vlan 8021q aggregator 3 trunk-link tag 3-20
<b>vlan 8021q aggregator</b> [PortNumber] <b>hybrid-link untag</b> [UntaggedVID] <b>tag</b> [TaggedVID List]	V	Assign a hybrid link for VLAN by trunk group	switch(vlan)# vlan 8021q aggregator 3 hybrid-link untag 4 tag 3,6,8 or switch(vlan)# vlan 8021q aggregator 3 hybrid-link untag 5 tag 6-8
<b>show vlan [VID]</b> or <b>show vlan</b>	V	Show VLAN information	switch(vlan)#show vlan 23

## 6.6 Commands Set List—Spanning Tree command set

IPS-3082GC / IPS-3082GC-24V Commands	Level	Description	Example
<b>spanning-tree enable</b>	G	Enable spanning tree	switch(config)#spanning-tree enable
<b>spanning-tree priority</b> [0to61440]	G	Configure spanning tree priority parameter	switch(config)#spanning-tree priority 32767
<b>spanning-tree max-age</b> [seconds]	G	Use the spanning-tree max-age global	switch(config)# spanning-tree max-age 15





		<p>configuration command to change the interval between messages the spanning tree receives from the root switch. If a switch does not receive a bridge protocol data unit (BPDU) message from the root switch within this interval, it recomputed the Spanning Tree Protocol (STP) topology.</p>	
<p><b>spanning-tree hello-time</b> [seconds]</p>	<p><b>G</b></p>	<p>Use the spanning-tree hello-time global configuration command to specify the interval between hello bridge protocol data units (BPDUs).</p>	<p>switch(config)#spanning-tree hello-time 3</p>
<p><b>spanning-tree forward-time</b> [seconds]</p>	<p><b>G</b></p>	<p>Use the spanning-tree forward-time global configuration command to set the forwarding-time for the specified spanning-tree instances. The forwarding time determines how long each of the listening and learning states last before the port begins</p>	<p>switch(config)# spanning-tree forward-time 20</p>



		forwarding.	
<b>stp-path-cost</b> [1to200000000]	I	Use the spanning-tree cost interface configuration command to set the path cost for Spanning Tree Protocol (STP) calculations. In the event of a loop, spanning tree considers the path cost when selecting an interface to place into the forwarding state.	switch(config)#interface fastEthernet 2 switch(config-if)#stp-path-cost 20
<b>stp-path-priority</b> [Port Priority]	I	Use the spanning-tree port-priority interface configuration command to configure a port priority that is used when two switches tie for position as the root switch.	switch(config)#interface fastEthernet 2 switch(config-if)# stp-path-priority 127
<b>stp-admin-p2p</b> [Auto True False]	I	Admin P2P of STP priority on this interface.	switch(config)#interface fastEthernet 2 switch(config-if)# stp-admin-p2p Auto
<b>stp-admin-edge</b> [True False]	I	Admin Edge of STP priority on this interface.	switch(config)#interface fastEthernet 2 switch(config-if)# stp-admin-edge True
<b>stp-admin-non-stp</b> [True False]	I	Admin NonSTP of STP priority on this interface.	switch(config)#interface fastEthernet 2 switch(config-if)# stp-admin-non-stp False



<b>Show spanning-tree</b>	<b>E</b>	Display a summary of the spanning-tree states.	switch>show spanning-tree
<b>no spanning-tree</b>	<b>G</b>	Disable spanning-tree.	switch(config)#no spanning-tree

## 6.7 Commands Set List—QoS command set

IPS-3082GC / IPS-3082GC-24V Commands	Level	Description	Example
<b>qos policy</b> [weighted-fair strict]	<b>G</b>	Select QOS policy scheduling	switch(config)#qos policy weighted-fair
<b>qos prioritytype</b> [port-based cos-only tos-only cos-first tos-first]	<b>G</b>	Setting of QOS priority type	switch(config)#qos prioritytype
<b>qos priority portbased</b> [Port] [lowest low middle high]	<b>G</b>	Configure Port-based Priority	switch(config)#qos priority portbased 1 low
<b>qos priority cos</b> [Priority][lowest low middle high]	<b>G</b>	Configure COS Priority	switch(config)#qos priority cos 22 middle
<b>qos priority tos</b> [Priority][lowest low middle high]	<b>G</b>	Configure TOS Priority	switch(config)#qos priority tos 3 high
<b>show qos</b>	<b>P</b>	Display the information of QoS configuration	switch>show qos
<b>no qos</b>	<b>G</b>	Disable QoS function	switch(config)#no qos

## 6.8 Commands Set List—IGMP command set

IPS-3082GC / IPS-3082GC-24V Commands	Level	Description	Example
<b>igmp enable</b>	<b>G</b>	Enable IGMP snooping function	switch(config)#igmp enable



<b>lgmp-query auto</b>	<b>G</b>	Set IGMP query to auto mode	switch(config)#lgmp-query auto
<b>lgmp-query force</b>	<b>G</b>	Set IGMP query to force mode	switch(config)#lgmp-query force
<b>show igmp configuration</b>	<b>P</b>	Displays the details of an IGMP configuration.	switch#show igmp configuration
<b>show igmp multi</b>	<b>P</b>	Displays the details of an IGMP snooping entries.	switch#show igmp multi
<b>no igmp</b>	<b>G</b>	Disable IGMP snooping function	switch(config)#no igmp
<b>no igmp-query</b>	<b>G</b>	Disable IGMP query	switch#no igmp-query

## 6.9 Commands Set List—MAC/Filter Table command set

IPS-3082GC / IPS-3082GC-24V Commands	Level	Description	Example
<b>mac-address-table static hwaddr</b> [MAC]	<b>I</b>	Configure MAC address table of interface (static).	switch(config)#interface fastEthernet 2 switch(config-if)#mac-address-table static hwaddr 000012345678
<b>mac-address-table filter hwaddr</b> [MAC]	<b>G</b>	Configure MAC address table(filter)	switch(config)#mac-address-table filter hwaddr 000012348678
<b>show mac-address-table</b>	<b>P</b>	Show all MAC address table	switch#show mac-address-table
<b>show mac-address-table static</b>	<b>P</b>	Show static MAC address table	switch#show mac-address-table static
<b>show mac-address-table filter</b>	<b>P</b>	Show filter MAC address table.	switch#show mac-address-table filter
<b>no mac-address-table static hwaddr</b> [MAC]	<b>I</b>	Remove an entry of MAC address table of interface (static)	switch(config)#interface fastEthernet 2 switch(config-if)#no mac-address-table static hwaddr 000012345678



<b>no mac-address-table filter hwaddr</b> [MAC]	<b>G</b>	Remove an entry of MAC address table (filter)	switch(config)#no mac-address-table filter hwaddr 000012348678
<b>no mac-address-table</b>	<b>G</b>	Remove dynamic entry of MAC address table	switch(config)#no mac-address-table

### 6.10 Commands Set List—SNMP command set

IPS-3082GC / IPS-3082GC-24V Commands	Level	Description	Example
<b>snmp agent-mode</b> [v1v2c   v3]	<b>G</b>	Select the agent mode of SNMP	switch(config)#snmp agent-mode v1v2c
<b>snmp-server host</b> [IP address] <b>community</b> [Community-string] <b>trap-version</b> [v1 v2c]	<b>G</b>	Configure SNMP server host information and community string	switch(config)#snmp-server host 192.168.10.50 community public trap-version v1 (remove) Switch(config)# no snmp-server host 192.168.10.50
<b>snmp community-strings</b> [Community-string] <b>right</b> [RO RW]	<b>G</b>	Configure the community string right	switch(config)#snmp community-strings public right RO or switch(config)#snmp community-strings public right RW
<b>snmp snmpv3-user</b> [User Name] <b>password</b> [Authentication Password] [Privacy Password]	<b>G</b>	Configure the userprofile for SNMPV3 agent. Privacy password could be empty.	switch(config)#snmp snmpv3-user test01 password AuthPW PrivPW
<b>show snmp</b>	<b>P</b>	Show SNMP configuration	switch#show snmp
<b>show snmp-server</b>	<b>P</b>	Show specified trap server information	switch#show snmp-server
<b>no snmp</b>	<b>G</b>	Remove the specified	switch(config)#no snmp



<b>community-strings</b> [Community]		community.	community-strings public
<b>no snmp snmpv3-user</b> [User Name] <b>password</b> [Authentication Password] [Privacy Password]	<b>G</b>	Remove specified user of SNMPv3 agent. Privacy password could be empty.	switch(config)# no snmp snmpv3-user test01 password AuthPW PrivPW
<b>no snmp-server host</b> [Host-address]	<b>G</b>	Remove the SNMP server host.	switch(config)#no snmp-server 192.168.10.50

### 6.11 Commands Set List—Port Mirroring command set

IPS-3082GC / IPS-3082GC-24V Commands	Level	Description	Example
<b>monitor rx</b>	<b>G</b>	Set RX destination port of monitor function	switch(config)#monitor rx
<b>monitor tx</b>	<b>G</b>	Set TX destination port of monitor function	switch(config)#monitor tx
<b>show monitor</b>	<b>P</b>	Show port monitor information	switch#show monitor
<b>monitor</b> [RX TX Both]	<b>I</b>	Configure source port of monitor function	switch(config)#interface fastEthernet 2 switch(config-if)#monitor RX
<b>show monitor</b>	<b>I</b>	Show port monitor information	switch(config)#interface fastEthernet 2 switch(config-if)#show monitor
<b>no monitor</b>	<b>I</b>	Disable source port of monitor function	switch(config)#interface fastEthernet 2 switch(config-if)#no monitor

### 6.12 Commands Set List—802.1x command set

IPS-3082GC /	Level	Description	Example
--------------	-------	-------------	---------



IPS-3082GC-24V Commands			
<b>8021x enable</b>	<b>G</b>	Use the 802.1x global configuration command to enable 802.1x protocols.	switch(config)# 8021x enable
<b>8021x system radiusip</b> [IP address]	<b>G</b>	Use the 802.1x system radius IP global configuration command to change the radius server IP.	switch(config)# 8021x system radiusip 192.168.1.1
<b>8021x system serverport</b> [port ID]	<b>G</b>	Use the 802.1x system server port global configuration command to change the radius server port	switch(config)# 8021x system serverport 1815
<b>8021x system accountport</b> [port ID]	<b>G</b>	Use the 802.1x system account port global configuration command to change the accounting port	switch(config)# 8021x system accountport 1816
<b>8021x system sharekey</b> [ID]	<b>G</b>	Use the 802.1x system share key global configuration command to change the shared key value.	switch(config)# 8021x system sharekey 123456
<b>8021x system nasid</b> [words]	<b>G</b>	Use the 802.1x system nasid global configuration command to change the NAS ID	switch(config)# 8021x system nasid test1
<b>8021x misc quietperiod</b> [sec.]	<b>G</b>	Use the 802.1x misc quiet period global configuration command to specify the quiet period value of the switch.	switch(config)# 8021x misc quietperiod 10



<b>8021x misc txperiod</b> [sec.]	<b>G</b>	Use the 802.1x misc TX period global configuration command to set the TX period.	switch(config)# 8021x misc txperiod 5
<b>8021x misc supportimeout</b> [sec.]	<b>G</b>	Use the 802.1x misc supp timeout global configuration command to set the supplicant timeout.	switch(config)# 8021x misc supportimeout 20
<b>8021x misc servertimeout</b> [sec.]	<b>G</b>	Use the 802.1x misc server timeout global configuration command to set the server timeout.	switch(config)#8021x misc servertimeout 20
<b>8021x misc maxrequest</b> [number]	<b>G</b>	Use the 802.1x misc max request global configuration command to set the MAX requests.	switch(config)# 8021x misc maxrequest 3
<b>8021x misc reauthperiod</b> [sec.]	<b>G</b>	Use the 802.1x misc reauth period global configuration command to set the reauth period.	switch(config)# 8021x misc reauthperiod 3000
<b>8021x portstate</b> [disable   reject   accept   authorize]	<b>I</b>	Use the 802.1x port state interface configuration command to set the state of the selected port.	switch(config)#interface fastethernet 3 switch(config-if)#8021x portstate accept
<b>show 8021x</b>	<b>E</b>	Display a summary of the 802.1x properties	switch>show 8021x





		and also the port sates.	
<b>no 8021x</b>	<b>G</b>	Disable 802.1x function	switch(config)#no 8021x

### 6.13 Commands Set List—TFTP command set

IPS-3082GC / IPS-3082GC-24V Commands	Level	Description	Defaults Example
<b>backup</b> <b>flash:backup_cfg</b>	<b>G</b>	Save configuration to TFTP and need to specify the IP of TFTP server and the file name of image.	switch(config)#backup flash:backup_cfg
<b>restore flash:restore_cfg</b>	<b>G</b>	Get configuration from TFTP server and need to specify the IP of TFTP server and the file name of image.	switch(config)#restore flash:restore_cfg
<b>upgrade</b> <b>flash:upgrade_fw</b>	<b>G</b>	Upgrade firmware by TFTP and need to specify the IP of TFTP server and the file name of image.	switch(config)#upgrade lash:upgrade_fw

### 6.14 Commands Set List—SYSLOG, SMTP, EVENT command set

IPS-3082GC / IPS-3082GC-24V Commands	Level	Description	Example
<b>systemlog ip</b> [IP address]	<b>G</b>	Set System log server IP address.	switch(config)# systemlog ip 192.168.1.100
<b>systemlog mode</b> [client server both]	<b>G</b>	Specified the log mode	switch(config)# systemlog mode both
<b>show systemlog</b>	<b>E</b>	Display system log.	Switch>show systemlog



<b>show systemlog</b>	<b>P</b>	Show system log client & server information	switch#show systemlog
<b>no systemlog</b>	<b>G</b>	Disable systemlog function	switch(config)#no systemlog
<b>smtp enable</b>	<b>G</b>	Enable SMTP function	switch(config)#smtp enable
<b>smtp serverip</b> [IP address]	<b>G</b>	Configure SMTP server IP	switch(config)#smtp serverip 192.168.1.5
<b>smtp authentication</b>	<b>G</b>	Enable SMTP authentication	switch(config)#smtp authentication
<b>smtp account</b> [account]	<b>G</b>	Configure authentication account	switch(config)#smtp account User
<b>smtp password</b> [password]	<b>G</b>	Configure authentication password	switch(config)#smtp password
<b>smtp rcptemail</b> [Index] [Email address]	<b>G</b>	Configure Rcpt e-mail Address	switch(config)#smtp rcptemail 1 <a href="mailto:Alert@test.com">Alert@test.com</a>
<b>show smtp</b>	<b>P</b>	Show the information of SMTP	switch#show smtp
<b>no smtp</b>	<b>G</b>	Disable SMTP function	switch(config)#no smtp
<b>event device-cold-start</b> [Systemlog SMTP Both]	<b>G</b>	Set cold start event type	switch(config)#event device-cold-start both
<b>event authentication-failure</b> [Systemlog SMTP Both]	<b>G</b>	Set Authentication failure event type	switch(config)#event authentication-failure both
<b>event O-Ring-topology-change</b> [Systemlog SMTP Both]	<b>G</b>	Set s ring topology changed event type	switch(config)#event ring-topology-change both
<b>event systemlog</b> [Link-UP Link-Down Both]	<b>I</b>	Set port event for system log	switch(config)#interface fastethernet 3 switch(config-if)#event systemlog both
<b>event smtp</b> [Link-UP Link-Down Both]	<b>I</b>	Set port event for SMTP	switch(config)#interface fastethernet 3 switch(config-if)#event smtp both



<b>show event</b>	<b>P</b>	Show event selection	switch#show event
<b>no event device-cold-start</b>	<b>G</b>	Disable cold start event type	switch(config)#no event device-cold-start
<b>no event authentication-failure</b>	<b>G</b>	Disable Authentication failure event typ	switch(config)#no event authentication-failure
<b>no event O-Ring-topology-change</b>	<b>G</b>	Disable O-Ring topology changed event type	switch(config)#no event ring-topology-change
<b>no event systemlog</b>	<b>I</b>	Disable port event for system log	switch(config)#interface fastethernet 3 switch(config-if)#no event systemlog
<b>no event smtp</b>	<b>I</b>	Disable port event for SMTP	switch(config)#interface fastethernet 3 switch(config-if)#no event smtp
<b>show systemlog</b>	<b>P</b>	Show system log client & server information	switch#show systemlog

### 6.15 Commands Set List—SNTP command set

IPS-3082GC / IPS-3082GC-24V Commands	Level	Description	Example
<b>sntp enable</b>	<b>G</b>	Enable SNTP function	switch(config)#sntp enable
<b>sntp daylight</b>	<b>G</b>	Enable daylight saving time, if SNTP function is inactive, this command can't be applied.	switch(config)#sntp daylight
<b>sntp daylight-period</b> [Start time] [End time]	<b>G</b>	Set period of daylight saving time, if SNTP function is inactive, this command can't be applied. Parameter format: [yyyymmdd-hh:mm]	switch(config)# sntp daylight-period 20060101-01:01 20060202-01-01



<b>sntp daylight-offset</b> [Minute]	<b>G</b>	Set offset of daylight saving time, if SNTP function is inactive, this command can't be applied.	switch(config)#sntp daylight-offset 3
<b>sntp ip</b> [IP]	<b>G</b>	Set SNTP server IP, if SNTP function is inactive, this command can't be applied.	switch(config)#sntp ip 192.169.1.1
<b>sntp timezone</b> [Timezone]	<b>G</b>	Set timezone index, use "show sntp timzezone" command to get more information of index number	switch(config)#sntp timezone 22
<b>show sntp</b>	<b>P</b>	Show SNTP information	switch#show sntp
<b>show sntp timezone</b>	<b>P</b>	Show index number of time zone list	switch#show sntp timezone
<b>no sntp</b>	<b>G</b>	Disable SNTP function	switch(config)#no sntp
<b>no sntp daylight</b>	<b>G</b>	Disable daylight saving time	switch(config)#no sntp daylight

### 6.16 Commands Set List—O-Ring command set

IPS-3082GC / IPS-3082GC-24V Commands	Level	Description	Example
<b>Ring enable</b>	<b>G</b>	Enable O-Ring	switch(config)# ring enable
<b>Ring master</b>	<b>G</b>	Enable ring master	switch(config)# ring master
<b>Ring couplering</b>	<b>G</b>	Enable couple ring	switch(config)# ring couplering
<b>Ring dualhoming</b>	<b>G</b>	Enable dual homing	switch(config)# ring dualhoming
<b>Ring ringport</b> [1st Ring Port] [2nd Ring Port]	<b>G</b>	Configure 1st/2nd Ring Port	switch(config)# ring ringport 7 8



<b>Ring couplingport</b> [Coupling Port]	<b>G</b>	Configure Coupling Port	switch(config)# ring couplingport 1
<b>Ring controlport</b> [Control Port]	<b>G</b>	Configure Control Port	switch(config)# ring controlport 2
<b>Ring homingport</b> [Dual Homing Port]	<b>G</b>	Configure Dual Homing Port	switch(config)# ring homingport 3
<b>show Ring</b>	<b>P</b>	Show the information of O-Ring	switch#show ring
<b>no Ring</b>	<b>G</b>	Disable O-Ring	switch(config)#no ring
<b>no Ring master</b>	<b>G</b>	Disable ring master	switch(config)# no ring master
<b>no Ring couplering</b>	<b>G</b>	Disable couple ring	switch(config)# no ring couplering
<b>no Ring dualhoming</b>	<b>G</b>	Disable dual homing	switch(config)# no ring dualhoming

# Technical Specifications

ORing Switch Model	IPS-3082GC	IPS-3082GC-24V
<b>Physical Ports</b>		
10/100 Base-T(X) Ports in RJ45 Auto MDI/MDIX with P.S.E.	<b>8</b>	
Gigabit Combo Ports with 10/100/1000Base-T(X) and 100/1000Base-X SFP port	<b>2</b>	
<b>Technology</b>		
Ethernet Standards	IEEE 802.3 for 10Base-T IEEE 802.3u for 100Base-TX and 100Base-FX IEEE 802.3z for 1000Base-X IEEE 802.3ab for 1000Base-T IEEE 802.3x for Flow control IEEE 802.3ad for LACP (Link Aggregation Control Protocol ) IEEE 802.1D for STP (Spanning Tree Protocol) IEEE 802.1p for COS (Class of Service) IEEE 802.1Q for VLAN Tagging IEEE 802.1w for RSTP (Rapid Spanning Tree Protocol) IEEE 802.1s for MSTP (Multiple Spanning Tree Protocol) IEEE 802.1x for Authentication IEEE 802.1AB for LLDP (Link Layer Discovery Protocol) IEEE 802.3af PoE specification (up to 15.4 Watts per port for P.S.E.)	
MAC Table	8192 MAC addresses	
Priority Queues	4	
Processing	Store-and-Forward	
Switch Properties	Switching latency: 7 us Switching bandwidth: 5.6Gbps Max. Number of Available VLANs: 4096 IGMP multicast groups: 1024 Port rate limiting: User Define	
Security Features	Enable/disable ports, MAC based port security Port based network access control (802.1x) VLAN (802.1Q ) to segregate and secure network traffic Supports Q-in-Q VLAN for performance & security to expand the VLAN space Radius centralized password management SNMP v1/v2c/v3 encrypted authentication and access security	
Software Features	STP/RSTP/MSTP (IEEE 802.1D/w/s) Redundant Ring (O-Ring) with recovery time less than 10ms over 250 units TOS/Diffserv supported Quality of Service (802.1p) for real-time traffic VLAN (802.1Q) with VLAN tagging and GVRP supported IGMP Snooping for multicast filtering Port configuration, status, statistics, monitoring, security SNTP for synchronizing of clocks over network Support <b>PTP Client</b> (Precision Time Protocol) clock synchronization DHCP Server / Client support Port Trunk support MVR (Multicast VLAN Registration) support	
Network Redundancy	O-Ring Open-Ring O-RSTP STP RSTP MSTP	
Warning / Monitoring System	Relay output for fault event alarming Syslog server / client to record and view events	



	Include SMTP for event warning notification via email Event selection support	
DDM Function	Voltage / Current / Temperature	
RS-232 Serial Console Port	RS-232 in RJ45 connector with console cable. 9600bps, 8, N, 1	
<b>LED indicators</b>		
Power/PoE Indicator	Green : Power LED x 3, Green : PoE LED x 8	
O-Ring Indicator	Green : Indicate system operated in O-Ring mode	
R.M. indicator	Green : Indicate system operated in O-Ring Master mode	
Fault indicator	Amber : Indicate unexpected event occurred	
10/100Base-T(X) RJ45 Port Indicator	Green for port Link/Act. Amber for Duplex/Collision	
10/100/1000Base-T(X) RJ45 Port Indicator	Green for Link/Act. Amber for 100Mbps indicator	
100/1000Base-X Fiber Port Indicator	Green for port Link/Act.	
<b>Fault contact</b>		
Relay	Relay output to carry capacity of 1A at 24VDC	
<b>Power</b>		
Redundant Input Power	Dual DC inputs. 48VDC on 6-pin terminal block	Dual DC inputs. 24 ~ 36VDC on 6-pin terminal block
Power Consumption (Typ.)	9 Watts (power consumption of P.S.E. is not included)	
Overload Current Protection	Present	
Reverse polarity protection	Not Presented	
<b>Physical Characteristic</b>		
Enclosure	IP-30	
Dimension (W x D x H)	74.3 (W) x 109.2 (D) x 153.6 (H) mm (2.93 x 4.3 x 6.05 inch)	
Weight (g)	1100 g	1210 g
<b>Environmental</b>		
Storage Temperature	-40 to 85°C (-40 to 185°F)	
Operating Temperature	-40 to 70°C (-40 to 158°F)	
Operating Humidity	5% to 95% Non-condensing	
<b>Regulatory approvals</b>		
EMI	FCC Part 15, CISPR (EN55022) class A	
EMS	EN61000-4-2 (ESD), EN61000-4-3 (RS), EN61000-4-4 (EFT), EN61000-4-5 (Surge), EN61000-4-6 (CS), EN61000-4-8, EN61000-4-11	
Shock	IEC60068-2-27	
Free Fall	IEC60068-2-32	
Vibration	IEC60068-2-6	
Safety	EN60950-1	
Warranty	5 years	